

構成内容				
No.	名称	数量	材質	色・表面処理
1	ボディ	1	PC + ABS	グレー
2	ベース	1	PC + ABS	グレー
3	ホック	1	PPO樹脂	ブラック
4	Raspberry Pi 取付用ビス (ナベタッピングM3 × 6)	2	ステンレス	無処理

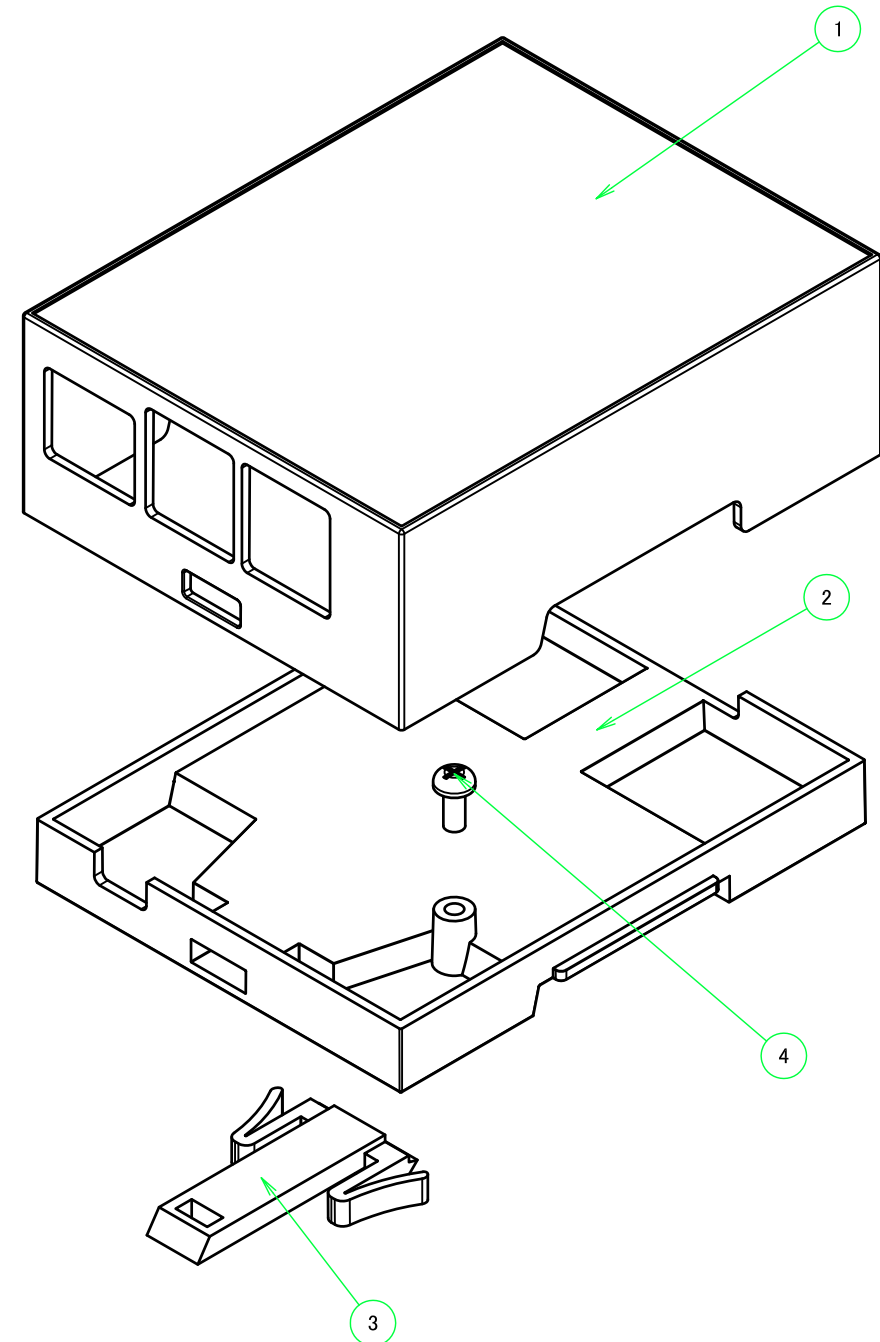

<b>株式会社タカチ電機工業</b> <small>TAKACHI ELECTRONICS ENCLOSURE CO., LTD.</small>			<b>品名/Title</b> Raspberry Pi 専用 DINモジュールボックス	 <b>尺度/Scale</b> 1:1
<b>承認/Approved</b> 中根	<b>検図/Checked</b> 横田	<b>製図/Created</b> 常山	<b>型番/Product number</b> RPD-1S	
			<b>作成日/Date</b> 2018/12/03	1 / 4

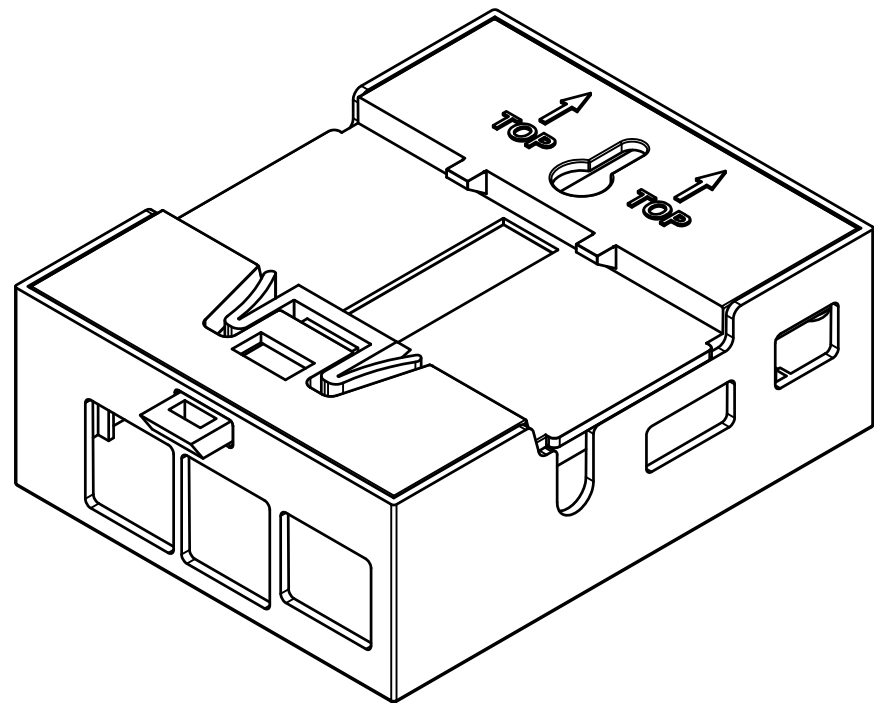
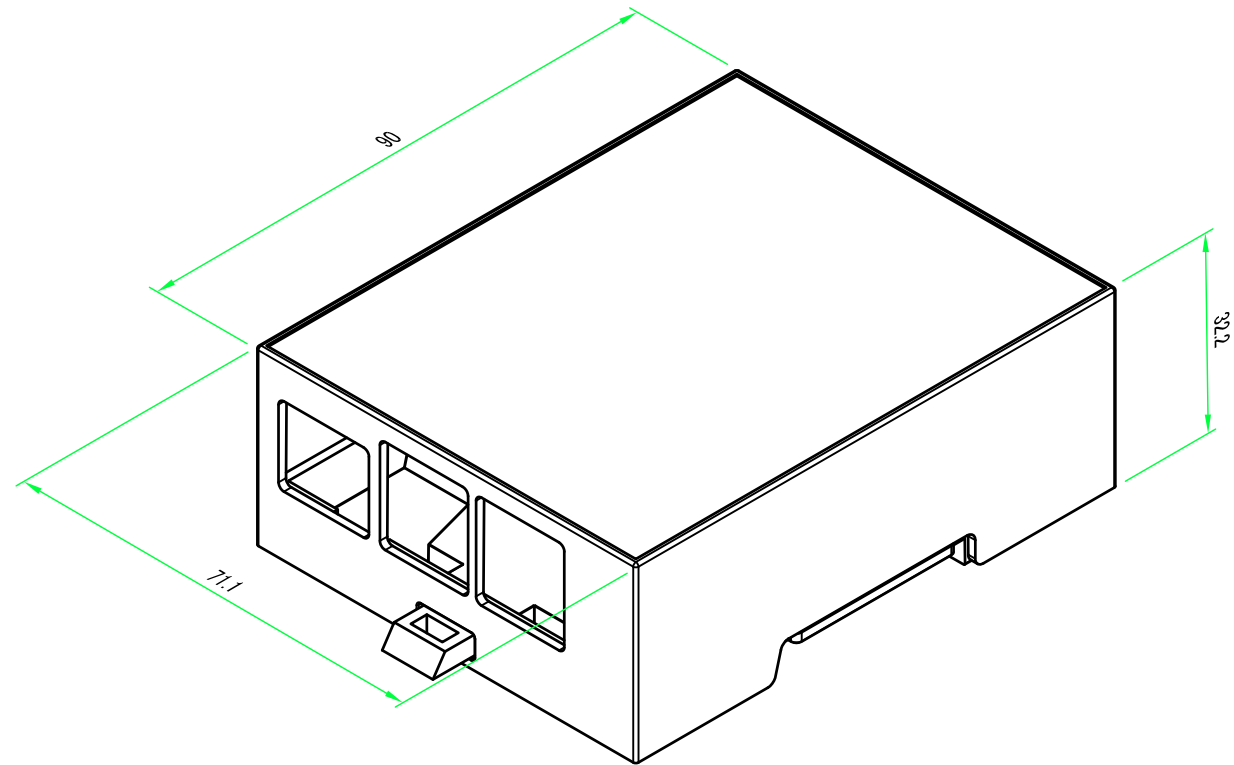
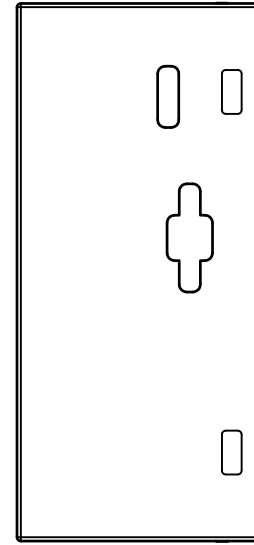
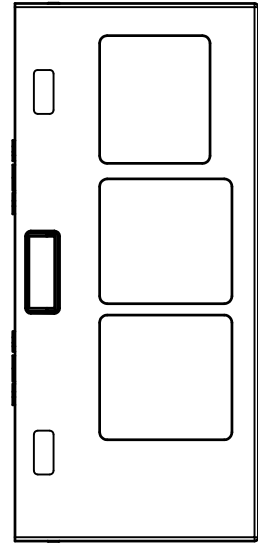
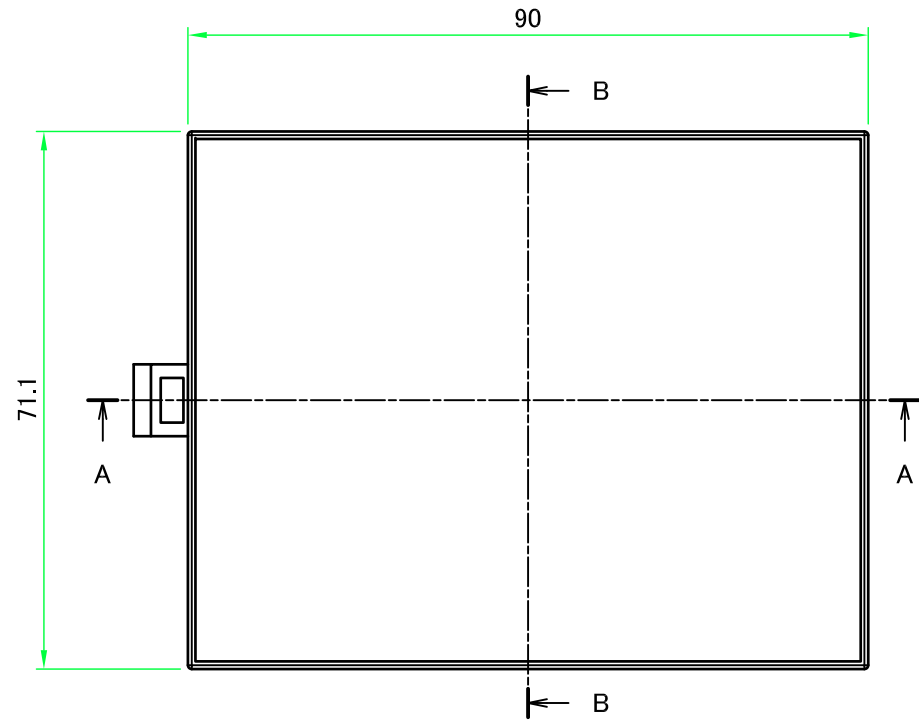
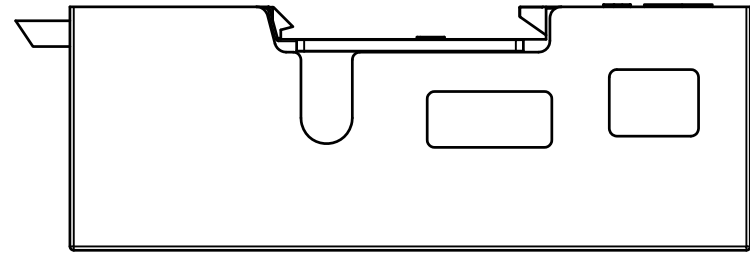

B-B (1:1)

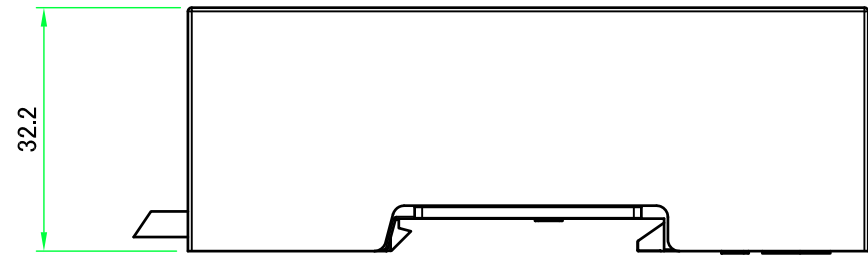
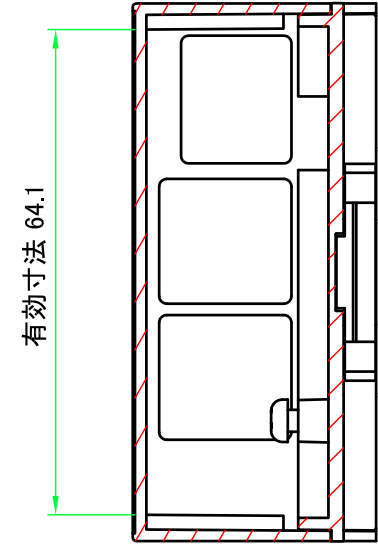

A-A (1:1)

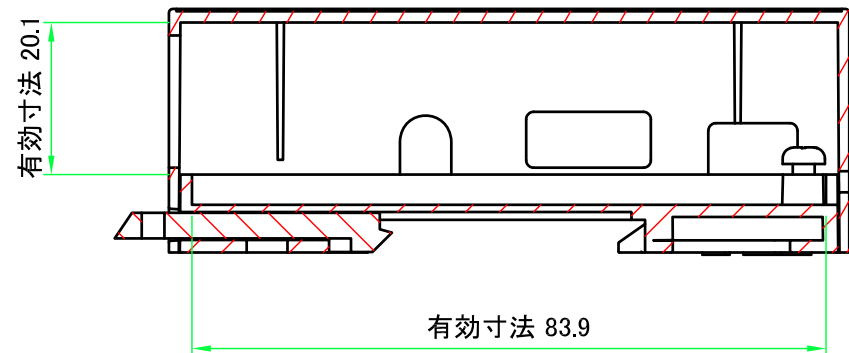

<b>株式会社タカチ電機工業</b> TAKACHI ELECTRONICS ENCLOSURE CO., LTD.			品名/Title Raspberry Pi 専用 DINモジュールボックス	尺度/Scale 1:1
承認/Approved	検図/Checked	製図/Created	型番/Product number RPD-1S	
中根	横田	常山	作成日/Date 2018/12/03	2 / 4

# ボディー

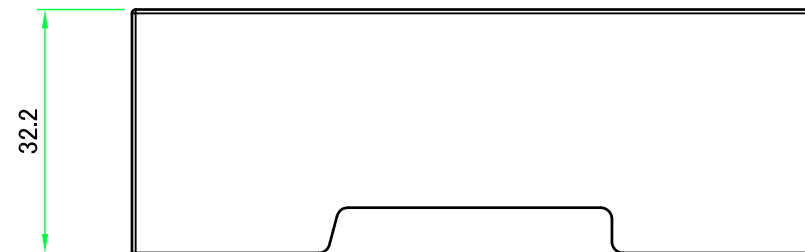
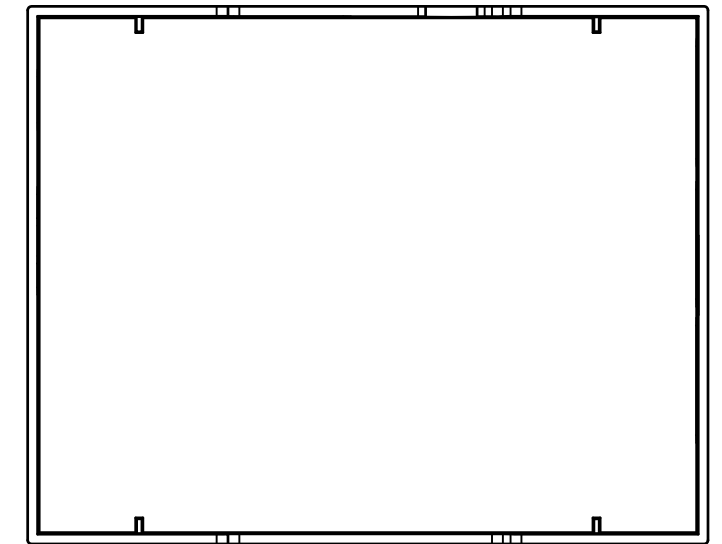
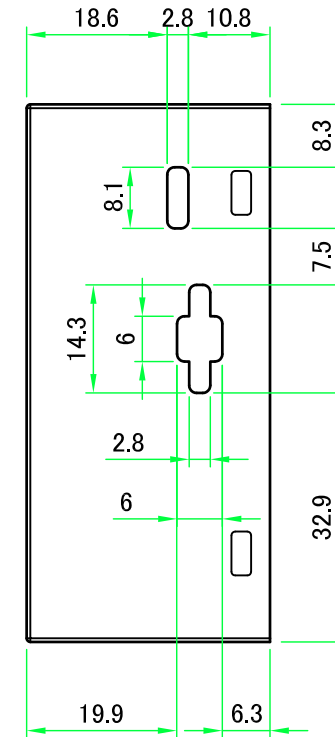
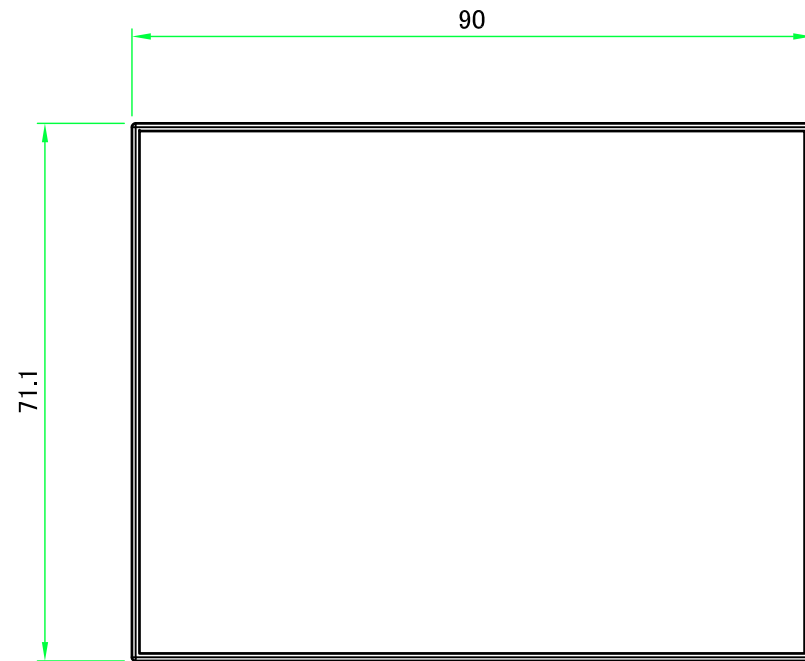
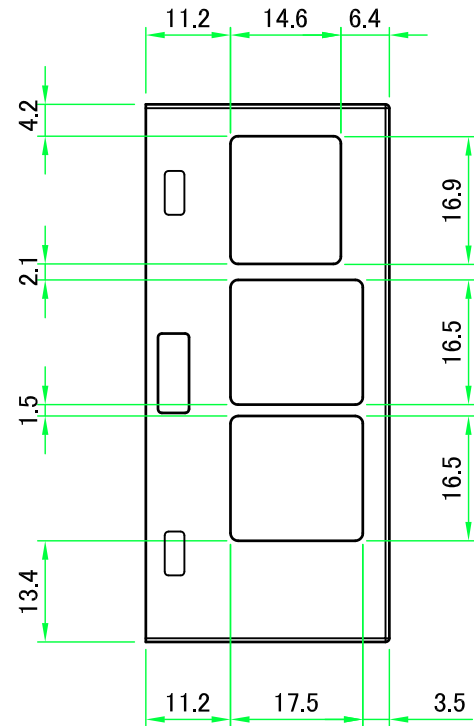
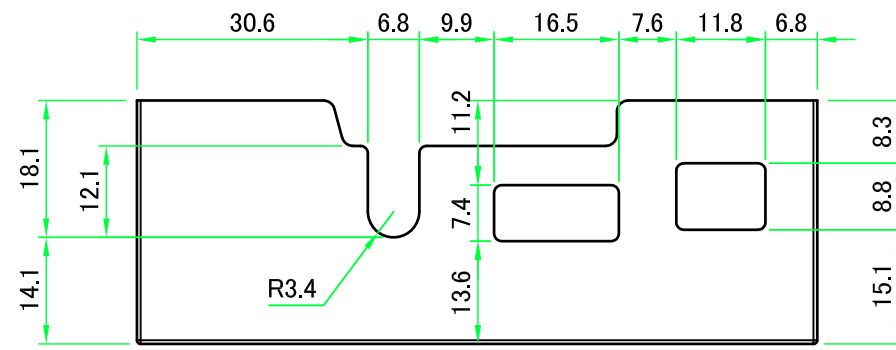

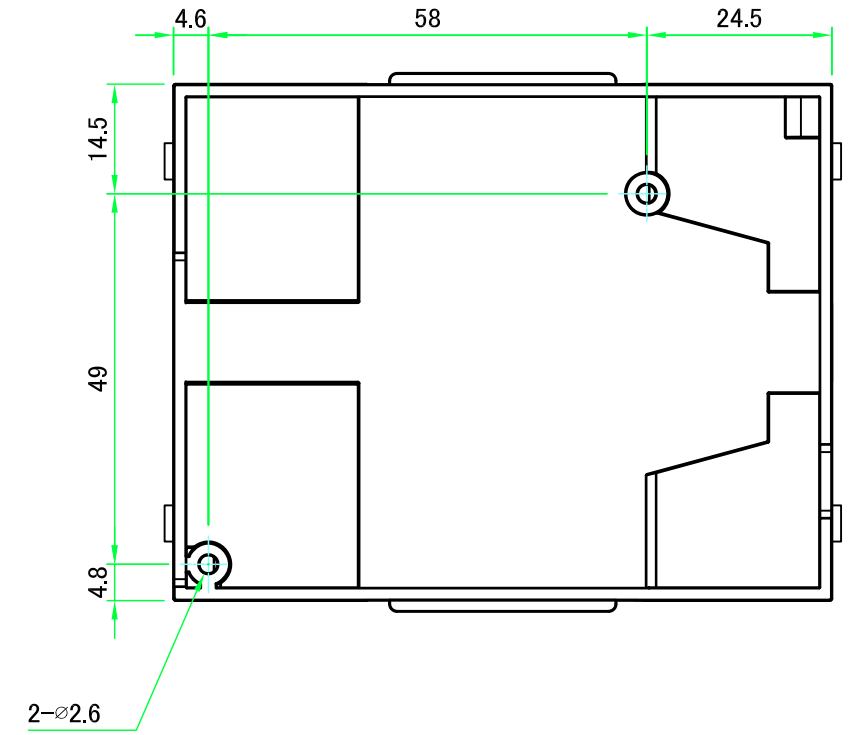
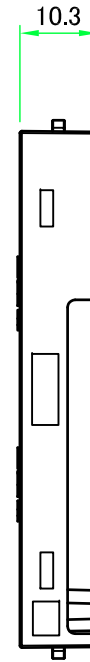
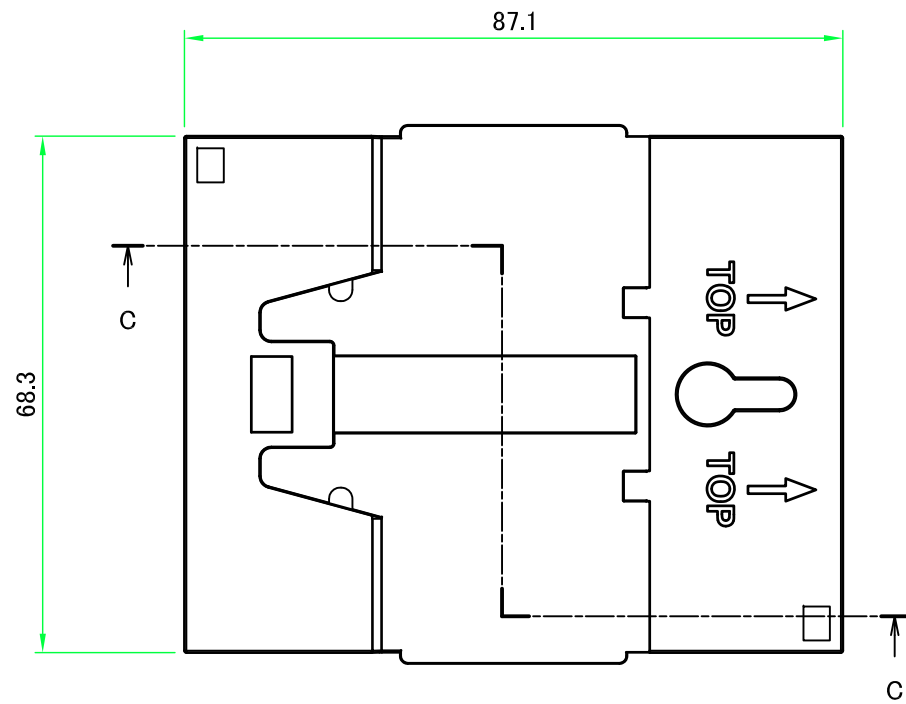
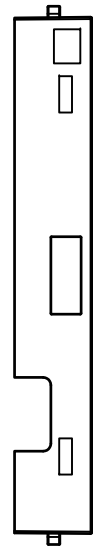
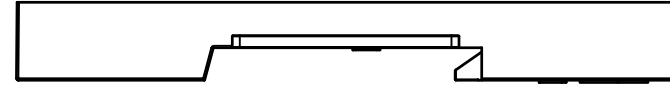

<b>株式会社タカチ電機工業</b> <small>TAKACHI ELECTRONICS ENCLOSURE CO., LTD.</small>		品名/Title Raspberry Pi 専用 DINモジュールボックス	尺度/Scale 1:1
承認/Approved	検図/Checked	製図/Created	
中根	横田	常山	作成日/Date 2018/12/03
			3 / 4

ベース

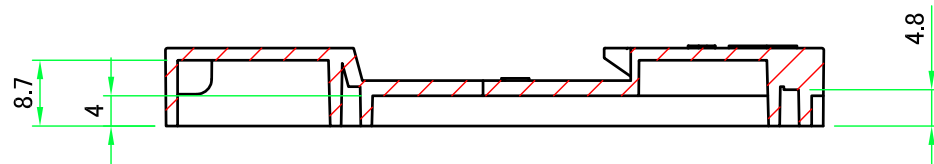

C-C (1:1)

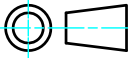

 株式会社タカチ電機工業 TAKACHI ELECTRONICS ENCLOSURE CO., LTD.			品名/Title Raspberry Pi 専用 DINモジュールボックス	 尺度/Scale 1:1
承認/Approved	検図/Checked	製図/Created	型番/Product number RPD-1S	
中根	横田	常山	作成日/Date 2018/12/03	4 / 4