

* ゴム足は任意の場所に貼り付けできます。
* Adhesive rubber feet in cluded.

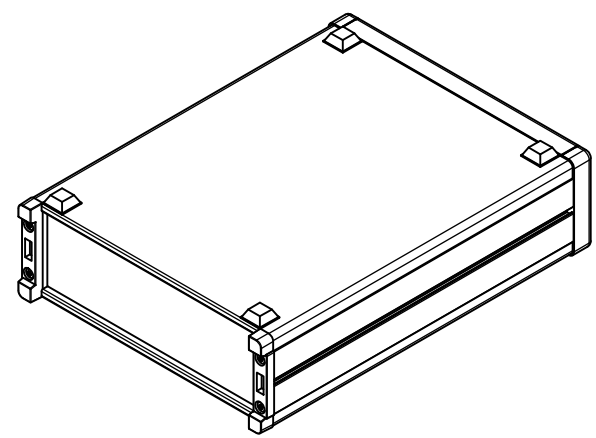

構成内容 / Components				
No.	名称 / Part name	数量 / Pcs	材質 / Material	色・表面処理 / Color・Finish
1	フロントパネル Front panel	1	アルミ板 A1100P Aluminium A1100P	シルバーアルマイト, ブラックアルマイト Silver anodized, Black anodized
2	リアパネル Rear panel	1	アルミ板 A1100P Aluminium A1100P	シルバーアルマイト, ブラックアルマイト Silver anodized, Black anodized
3	サイドフレーム Side frame	2	アルミ押出材 A6063S-T5 Extruded aluminium A6063S-T5	グレー塗装, ブラック塗装 Gray painted, Black painted
4	フロントフレーム Front frame	2	アルミ押出材 A6063S-T5 Extruded aluminium A6063S-T5	グレー塗装, ブラック塗装 Gray painted, Black painted
5	リアフレーム Rear frame	2	アルミ押出材 A6063S-T5 Extruded aluminium A6063S-T5	シルバーアルマイト Silver anodized
6	上カバー / Top cover	1	鋼板 SPCC / Steel SPCC	ライトグレー塗装, ブラック塗装 / Light gray painted, Black painted
7	下カバー / Bottom cover	1	鋼板 SPCC / Steel SPCC	ライトグレー塗装, ブラック塗装 / Light gray painted, Black painted
8	コーナーブロック Corner block	2	アルミダイキャスト ADC12 Diecast aluminium ADC12	グレー塗装, ブラック塗装 Gray painted, Black painted
9	リアフィート Rear feet	2	難燃性ABS樹脂 UL94V-0 Flame-resistant ABS UL94V-0	グレー, ブラック Gray, Black
10	ゴム足 / Rubber feet	4	ポリウレタン / Polyurethane	ブラック / Black
11	取付ビス(M4 x 6 サラ) Screw (M4 - 6 Countersunk)	4	鉄 Steel	三価クロメート Trivalent chromate
12	取付ビス(M4 x 8 ナベ) Screw (M4 - 8 Pan head)	8	鉄 Steel	三価クロメート Trivalent chromate
13	取付ビス(M4 x 10 バインド) Screw (M4 - 10 Binding head)	4	鉄 Steel	三価黒クロメート Black trivalent chromate

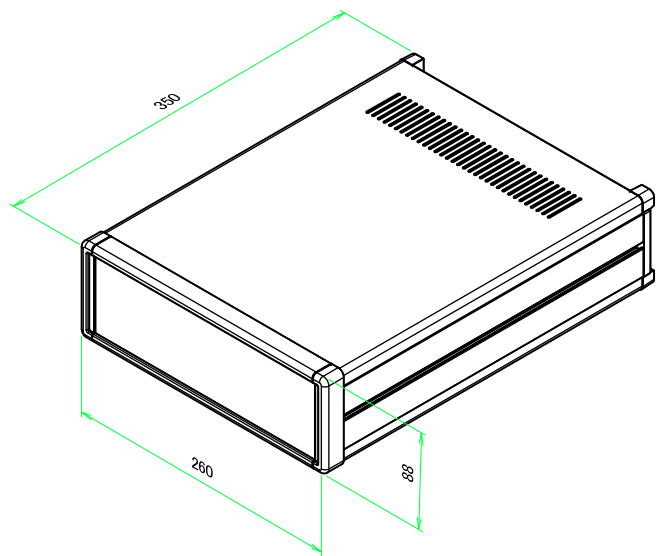

色仕様(型番末尾□) / Color type (End of product number□)				TAKACHI 株式会社タカチ電機工業 TAKACHI ELECTRONICS ENCLOSURE CO., LTD.			品名/Title メタルシステムケース METAL SYSTEM ENCLOSURE		尺度/Scale 1 / 8
記号 / Code	パネル / Panel	上下カバー / Top・Bottom cover	サイドフレーム / Side frame	承認/Approved	検図/Checked	製図/Created	型番/Product number		
G	シルバー / Silver	ライトグレー / Light gray	グレー / Gray	中根	王	野村	MS88-26-35□		
B	ブラック / Black	ブラック / Black	ブラック / Black						
B S	シルバー / Silver	ブラック / Black	ブラック / Black						
							作成日/Date	2020/03/02	

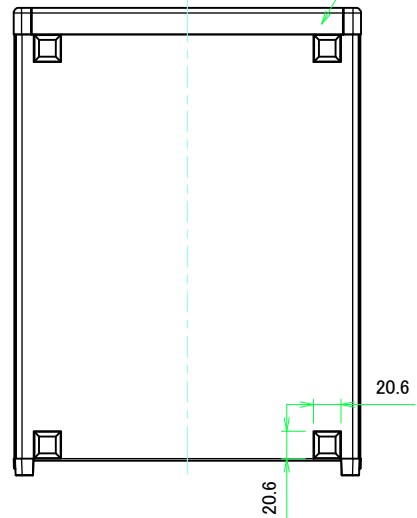
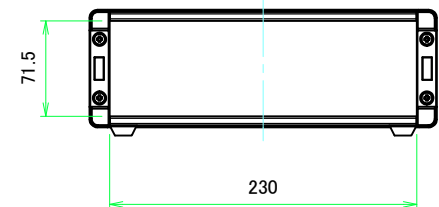
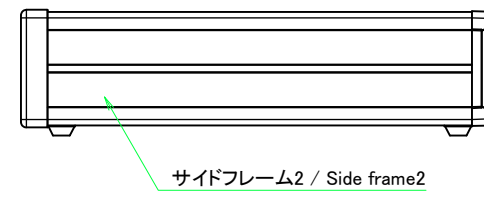
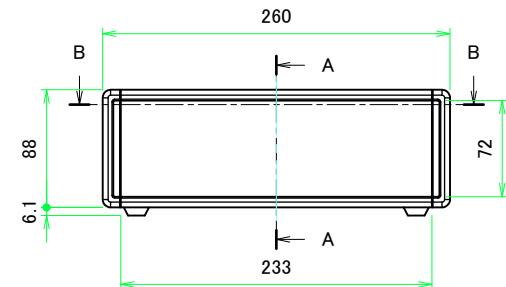
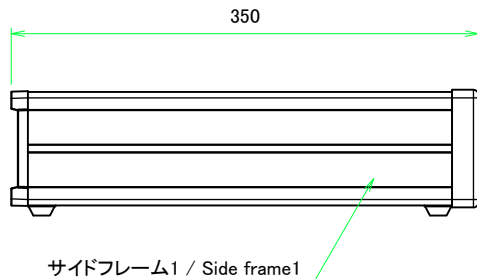
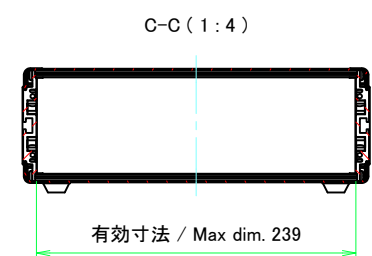
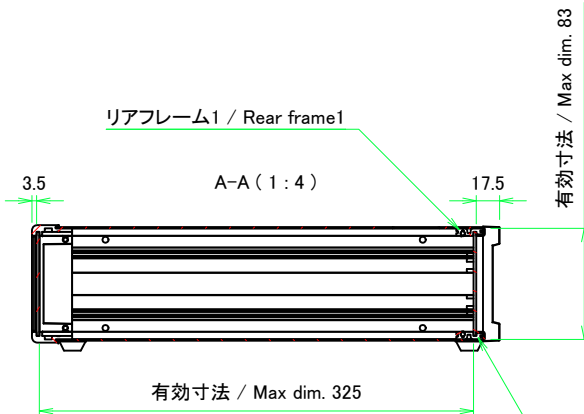
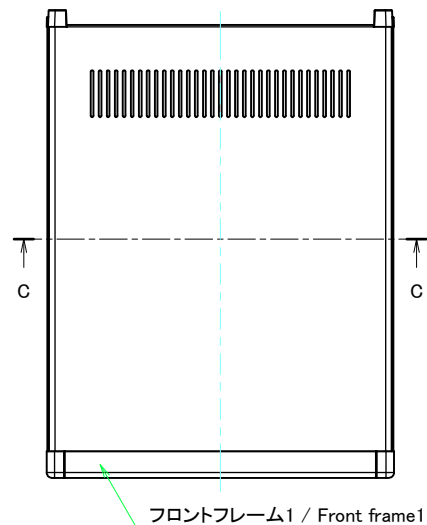
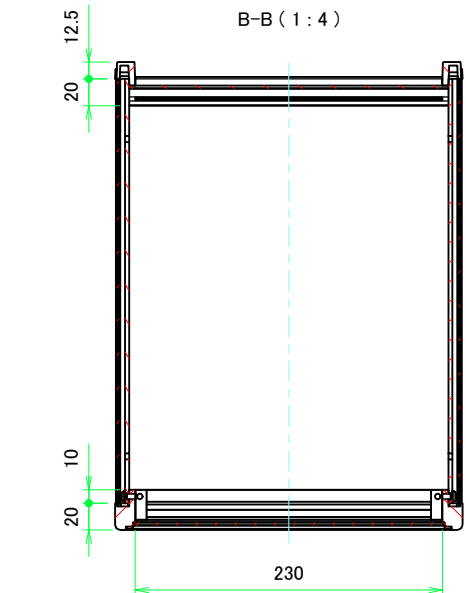

株式会社タカチ電機工業 TAKACHI ELECTRONICS ENCLOSURE CO., LTD.			品名/Title メタルシステムケース DESKTOP ENCLOSURE	尺度/Scale 1:4
承認/Approved	検図/Checked	製図/Created	型番/Product number MS88-26-35□	
中根	王	野村	作成日/Date 2020/03/02	2 / 8

フロントパネル / Front panel

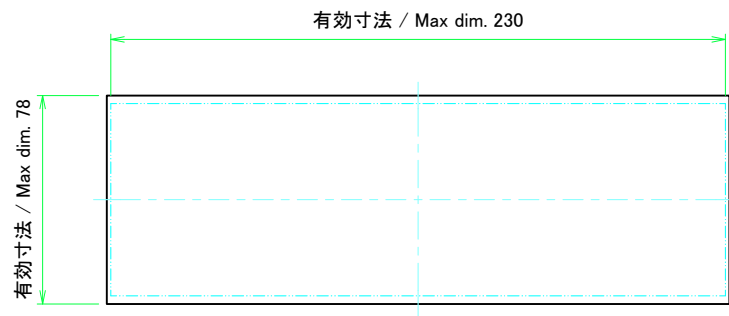

表面 / Front side

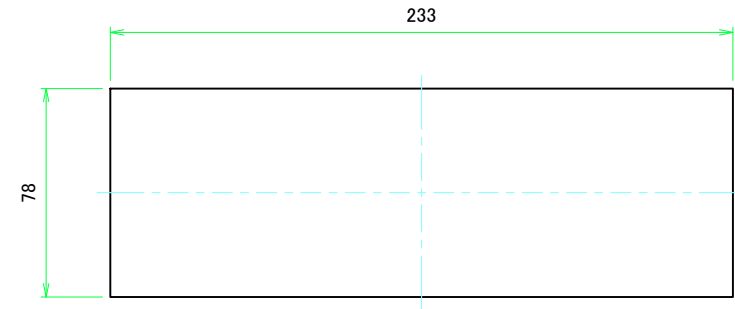
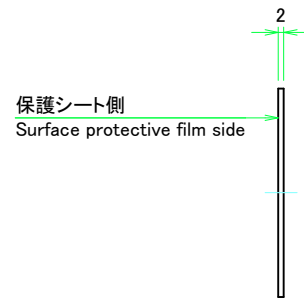

裏面 / Back side

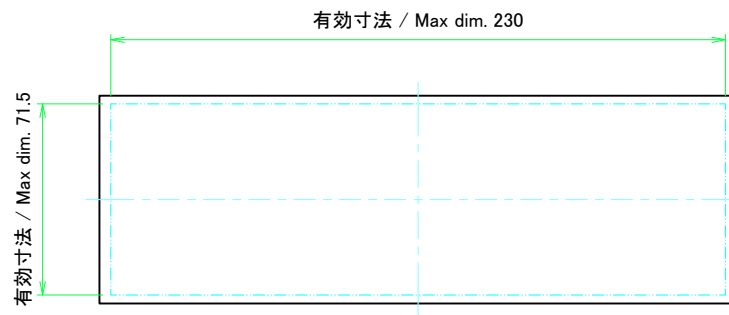

リアパネル / Rear panel

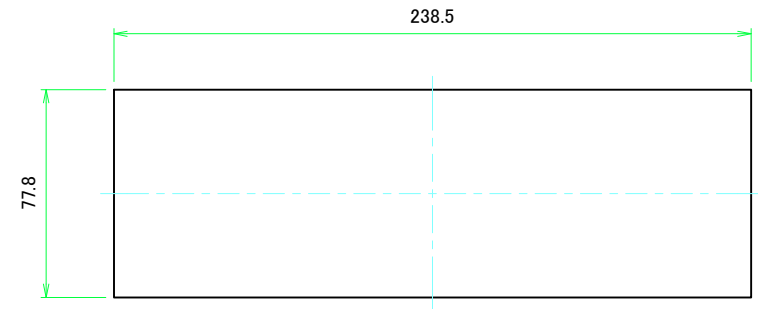
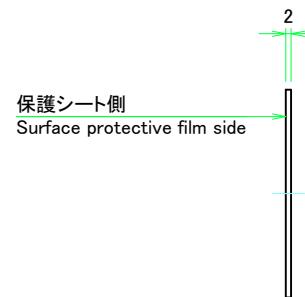

表面 / Front side



裏面 / Back side

 株式会社タカチ電機工業 <small>TAKACHI ELECTRONICS ENCLOSURE CO., LTD.</small>			品名/Title フロントパネル, リアパネル Front panel, Rear panel	 尺度/Scale 1:2
承認/Approved 中根	検図/Checked 王	製図/Created 野村	型番/Product number H88 - W260 作成日/Date 2020/03/02	

フロント側 / Front side

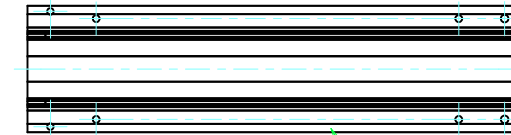
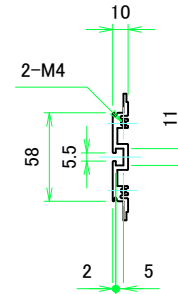
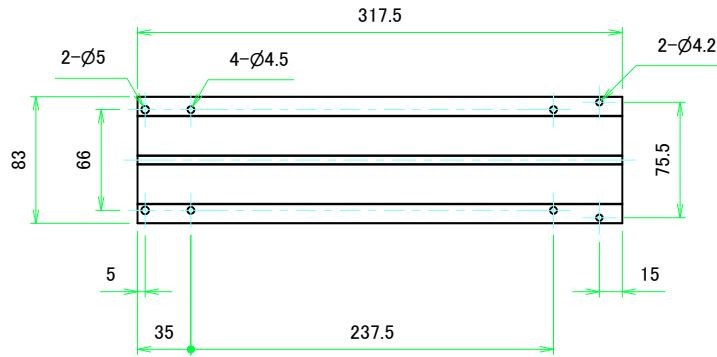

サイドフレーム1 / Side frame1

フロント側 / Front side

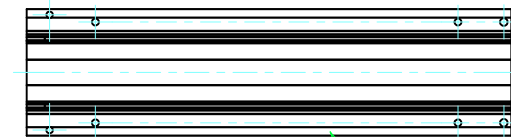
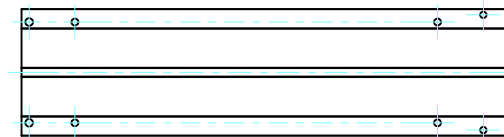

サイドフレーム2 / Side frame2

株式会社タカチ電機工業 TAKACHI ELECTRONICS ENCLOSURE CO., LTD.			品名/Title サイドフレーム Side frame	尺度/Scale 1:3.5
承認/Approved	検図/Checked	製図/Created	型番/Product number H88 - D350	
中根	王	野村	作成日/Date 2020/03/02	4 / 8

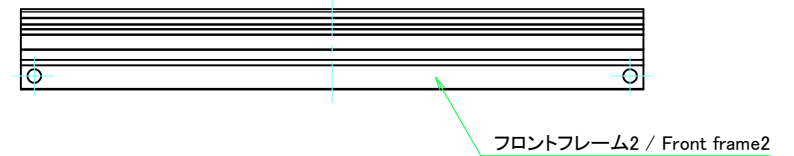
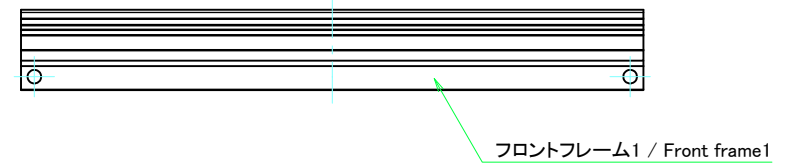
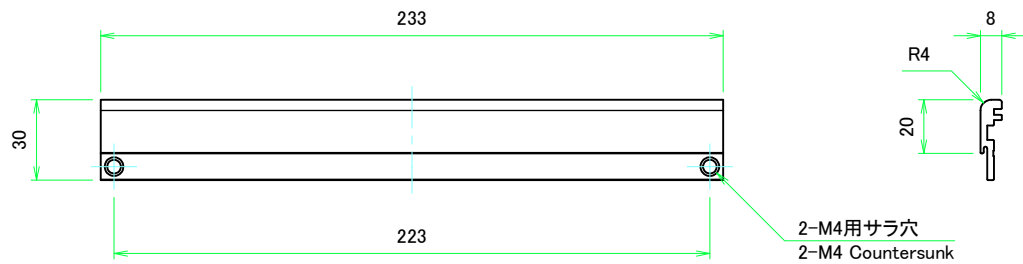

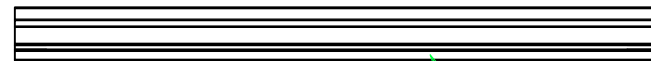
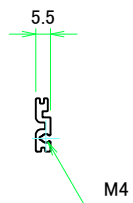
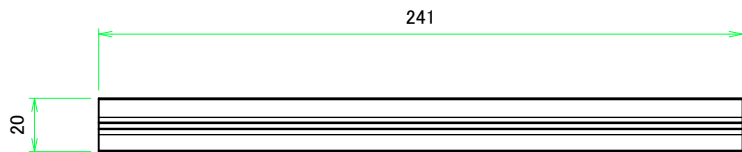

株式会社タカチ電機工業 TAKACHI ELECTRONICS ENCLOSURE CO., LTD.			品名/Title フロントフレーム Front frame	尺度/Scale 1:2
承認/Approved 中根	検図/Checked 王	製図/Created 野村	型番/Product number W260	
			作成日/Date 2020/03/02	5 / 8

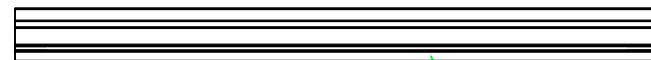
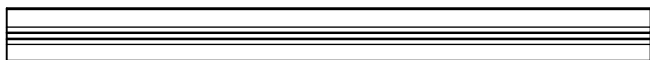

リアフレーム1 / Rear frame1



リアフレーム2 / Rear frame2

 株式会社タカチ電機工業 <small>TAKACHI ELECTRONICS ENCLOSURE CO., LTD.</small>			品名/Title リアフレーム Rear frame	 尺度/Scale 1:2
承認/Approved 中根	検図/Checked 王	製図/Created 野村	型番/Product number W260	
			作成日/Date 2020/03/02	6 / 8

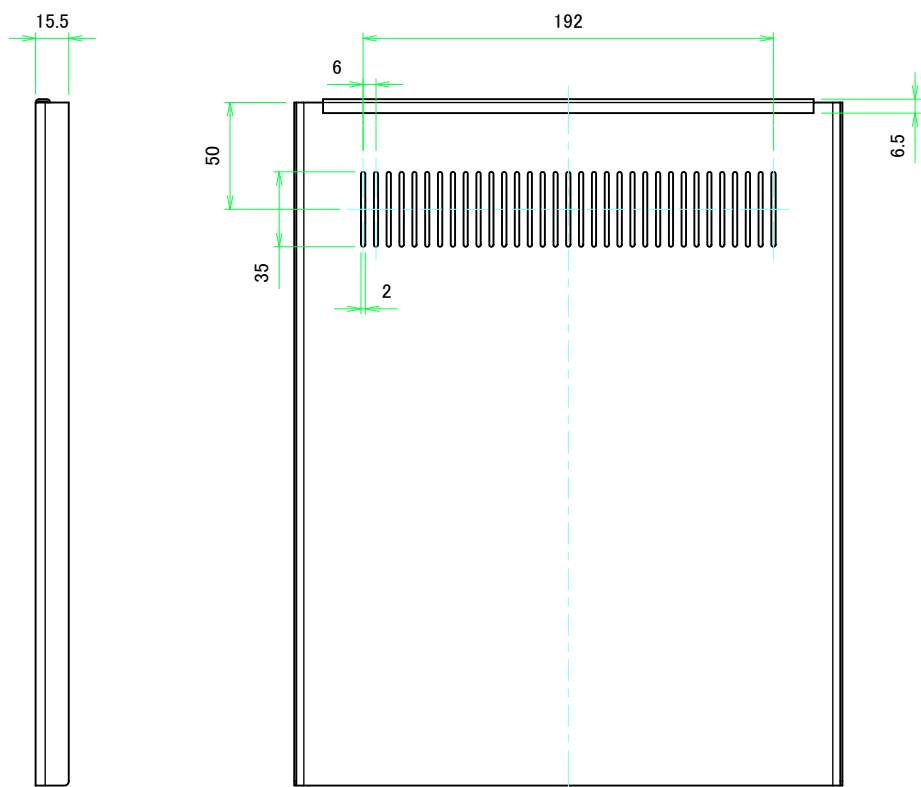
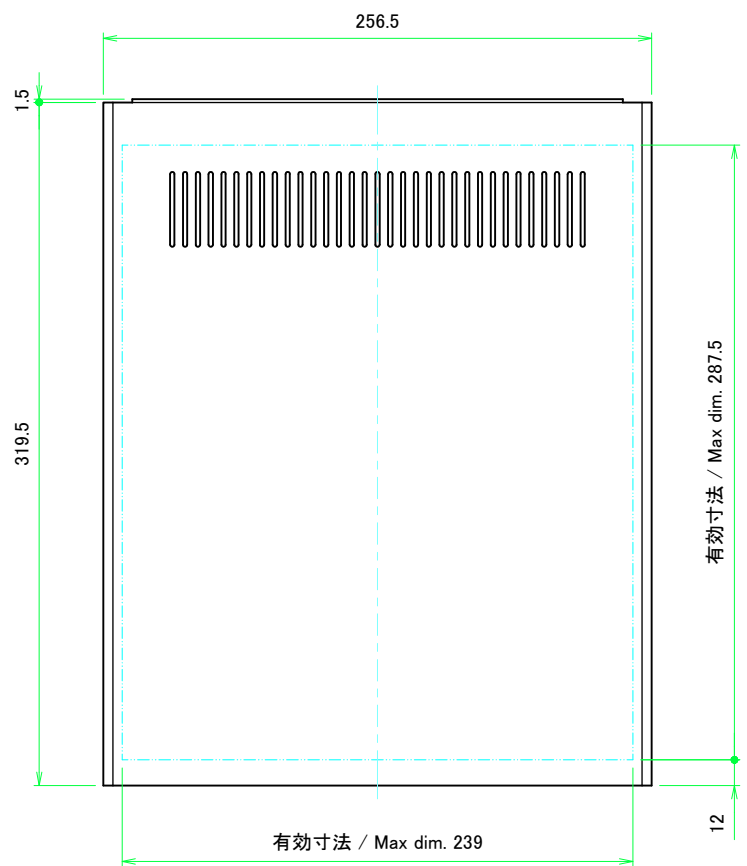
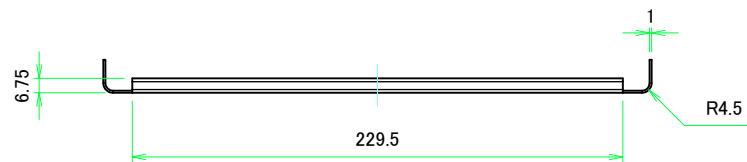

株式会社タカチ電機工業 TAKACHI ELECTRONICS ENCLOSURE CO., LTD.			品名/Title 上カバー Top cover	尺度/Scale 1:2.5
承認/Approved 中根	検図/Checked 王	製図/Created 野村	型番/Product number W260 - D350	
			作成日/Date 2020/03/02	7 / 8

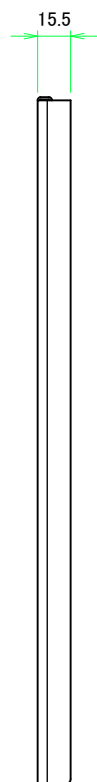
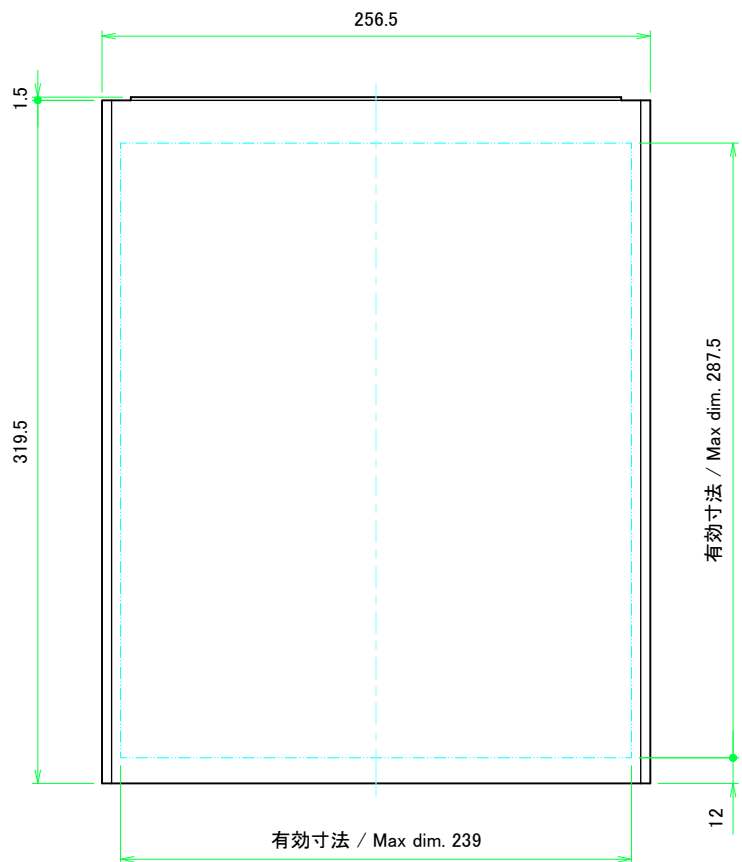
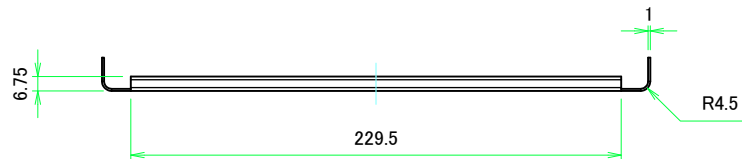

株式会社タカチ電機工業 TAKACHI ELECTRONICS ENCLOSURE CO., LTD.			品名/Title 下カバー Bottom cover	尺度/Scale 1:2.5
承認/Approved	検図/Checked	製図/Created	型番/Product number W260 - D350	
中根	王	野村	作成日/Date 2020/03/02	8 / 8