

取付方法1(シャーシ下5.5mm) / How to fix 1

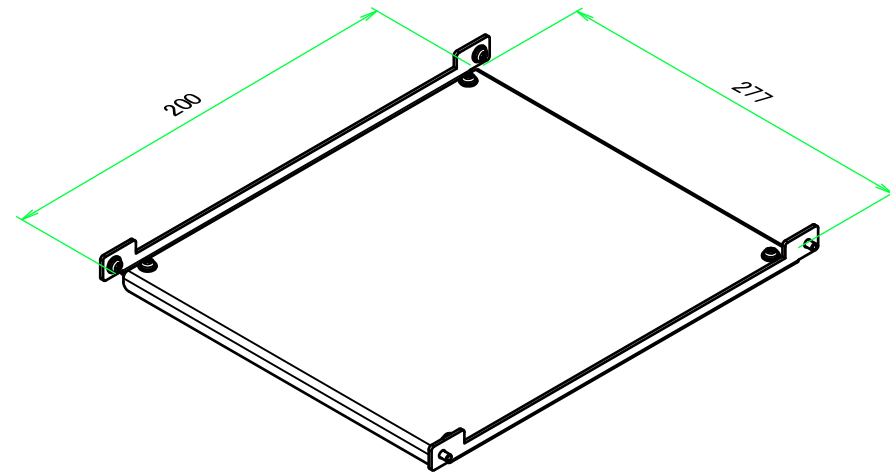

■テクニカルデータ / Technical Data■
 対応ケース / Suitable case : HY□-33-23

構成内容 / Components				
No.	名称 / Part name	数量 / Pcs	材質 / Material	色・表面処理 / Color・Finish
1	シャーシ Mounting plate	1	アルミ板 A1050P Aluminium A1050P	無処理 Unfinished
2	L型取付金具 L-bracket	2	鋼板 SPCC Steel SPCC	三価クロメート Trivalent chromate
3	取付ビス(M3 x 6 ナベ ワッシャー付) Screw (M3 - 6 Pan head)	8	鉄 Steel	三価クロメート Trivalent chromate

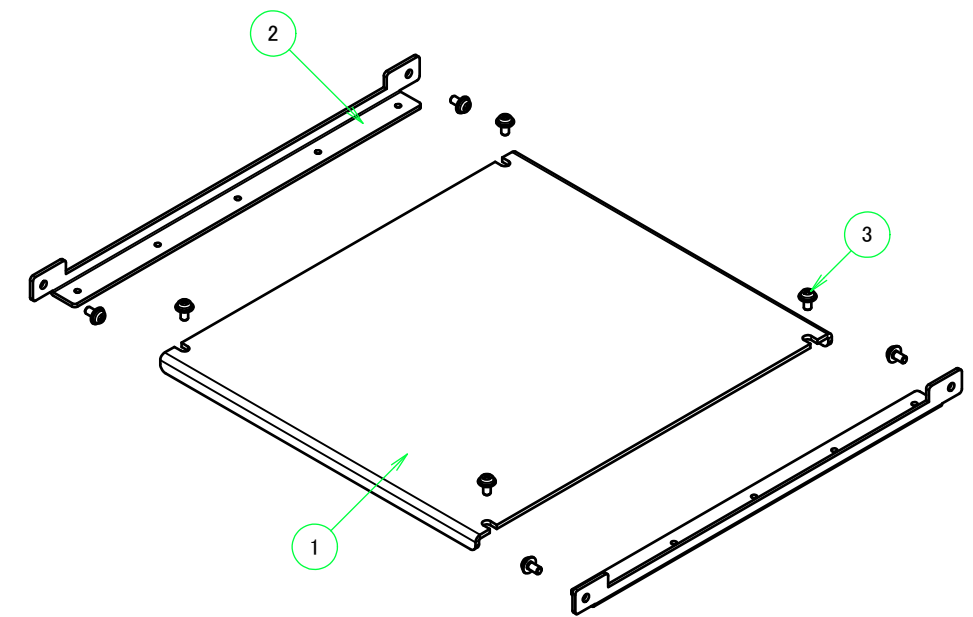
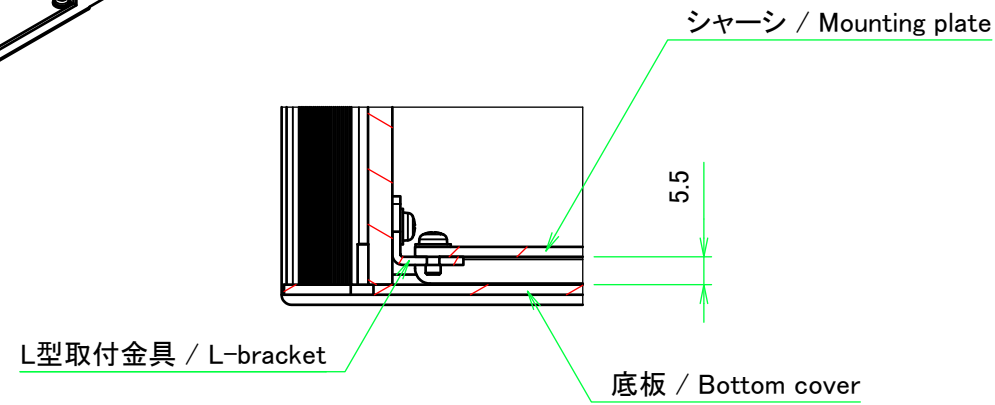

取付方法2(シャーシ下19.1mm) / How to fix 2

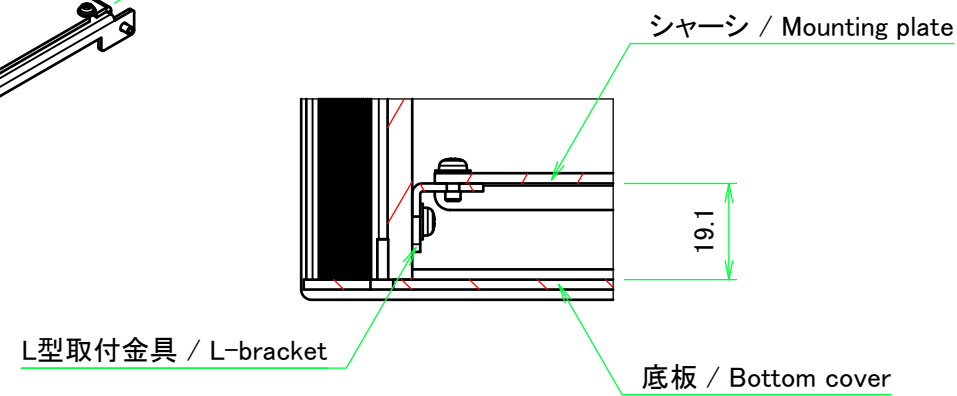
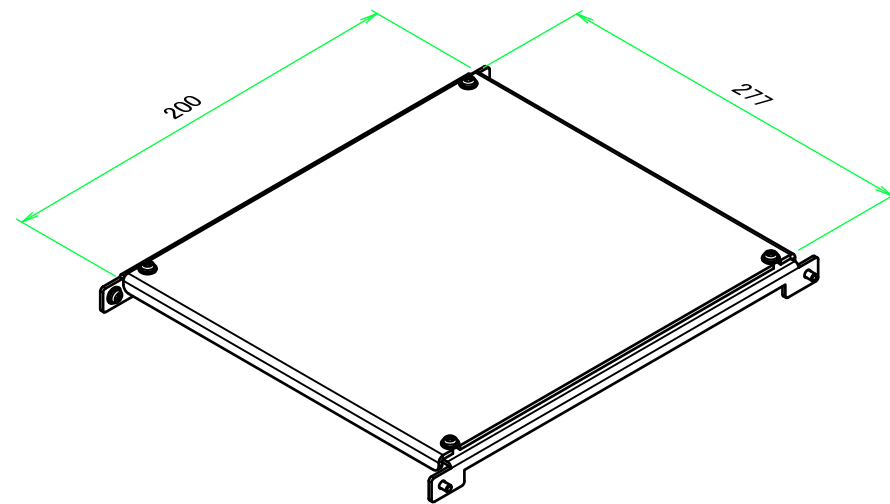

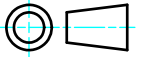
TAKACHI 株式会社タカチ電機工業 TAKACHI ELECTRONICS ENCLOSURE CO., LTD.		品名/Title HY専用シャーシ MOUNTING PLATE for HY		 尺度/Scale
承認/Approved	検図/Checked	製図/Created	型番/Product number HYC23-33	
	王	野村	作成日/Date 2017/06/21	1 / 2

シャーシ / Mounting plate

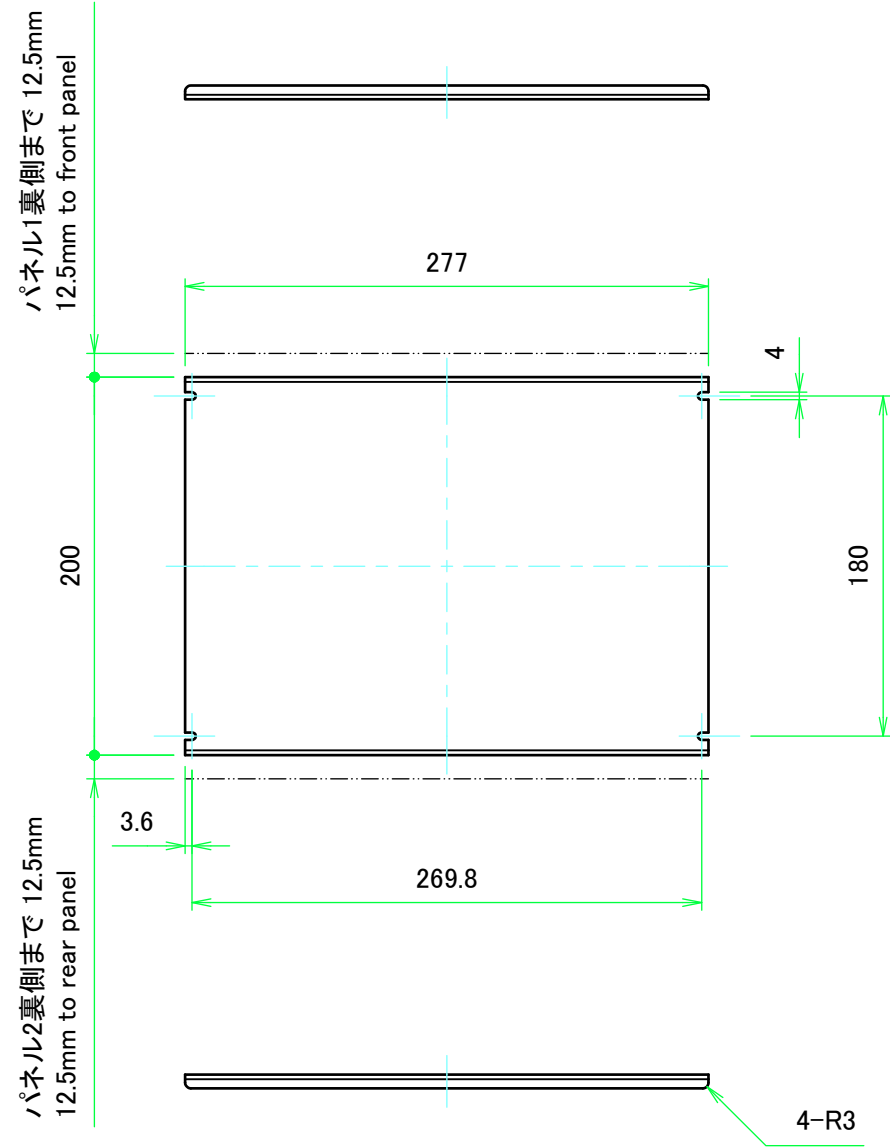

L型取付金具 / L-bracket

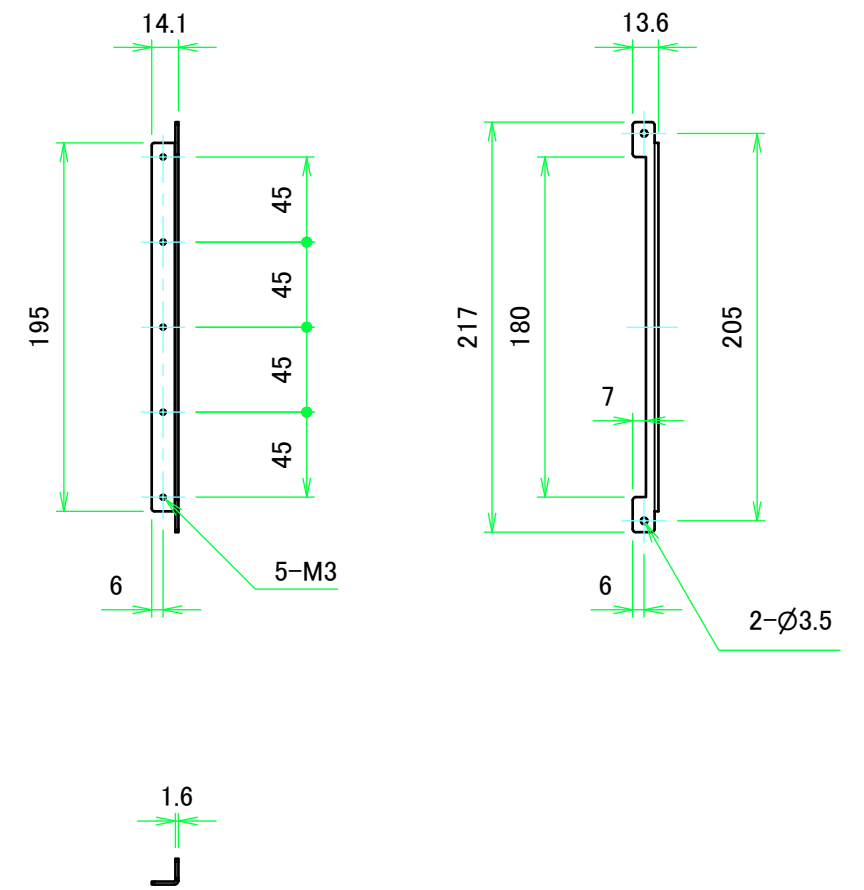

株式会社タカチ電機工業 TAKACHI ELECTRONICS ENCLOSURE CO., LTD.		品名/Title HY専用シャーシ MOUNTING PLATE for HY	尺度/Scale 1:4
承認/Approved	検図/Checked	製図/Created	
	王	野村	作成日/Date 2017/06/21
			2 / 2