

| 構成内容 / Components |   |          |  |   |
|-------------------|---|----------|--|---|
| No.               | 名称 / Part name  | 数量 / Pcs | 材質 / Material  | 色・表面処理 / Color・Finish   |
| 1                 | フレーム<br>Frame   | 4        | アルミ押出材 A6063S-T5<br>Extruded aluminium A6063S-T5               | シルバー, ブラック・アルマイト & クリア塗装<br>Silver, black・Anodized & clear coated |
| 2                 | コーナーブロック<br>Corner block                                      | 4        | ABS樹脂 UL94HB<br>ABS UL94HB                                     | ライトグレー, ブラック<br>Light gray, Black                                 |
| 3                 | コーナーキャップ / Blind plug   | 8        | エラストマ / TPE  | ライトグレー, ブラック / Light gray, Black                                  |
| 4                 | ハメ込みパネル / Slided panel  | 1        | アルミ板 / Aluminium A1100P t=1.5<br>アルミ板 / Aluminium A1100P t=1.5 | シルバーアルマイト / Silver・Anodized<br>ブラック・塗装 / Black・Painted            |
| 5                 | ねじ止めパネル / Screwed panel                                       | 1        | アルミ板 / Aluminium A1100P t=1.5<br>アルミ板 / Aluminium A1100P t=1.5 | シルバーアルマイト / Silver・Anodized<br>ブラック・塗装 / Black・Painted            |
| 6                 | 取付ビス(M3 x 15 ナベ)<br>Screw(M3 - 15 Pan head)                   | 16       | 鉄<br>Steel   | 三価クロメート<br>Trivalent chromate                                     |
| 7                 | 取付ビス(M3 x 5 座付丸皿)<br>Screw(M3 - 5 Slotted raised countersunk) | 4        | 鉄<br>Steel   | ニッケルメッキ, 三価黒クロメート<br>Nickel plated, Black trivalent chromate      |

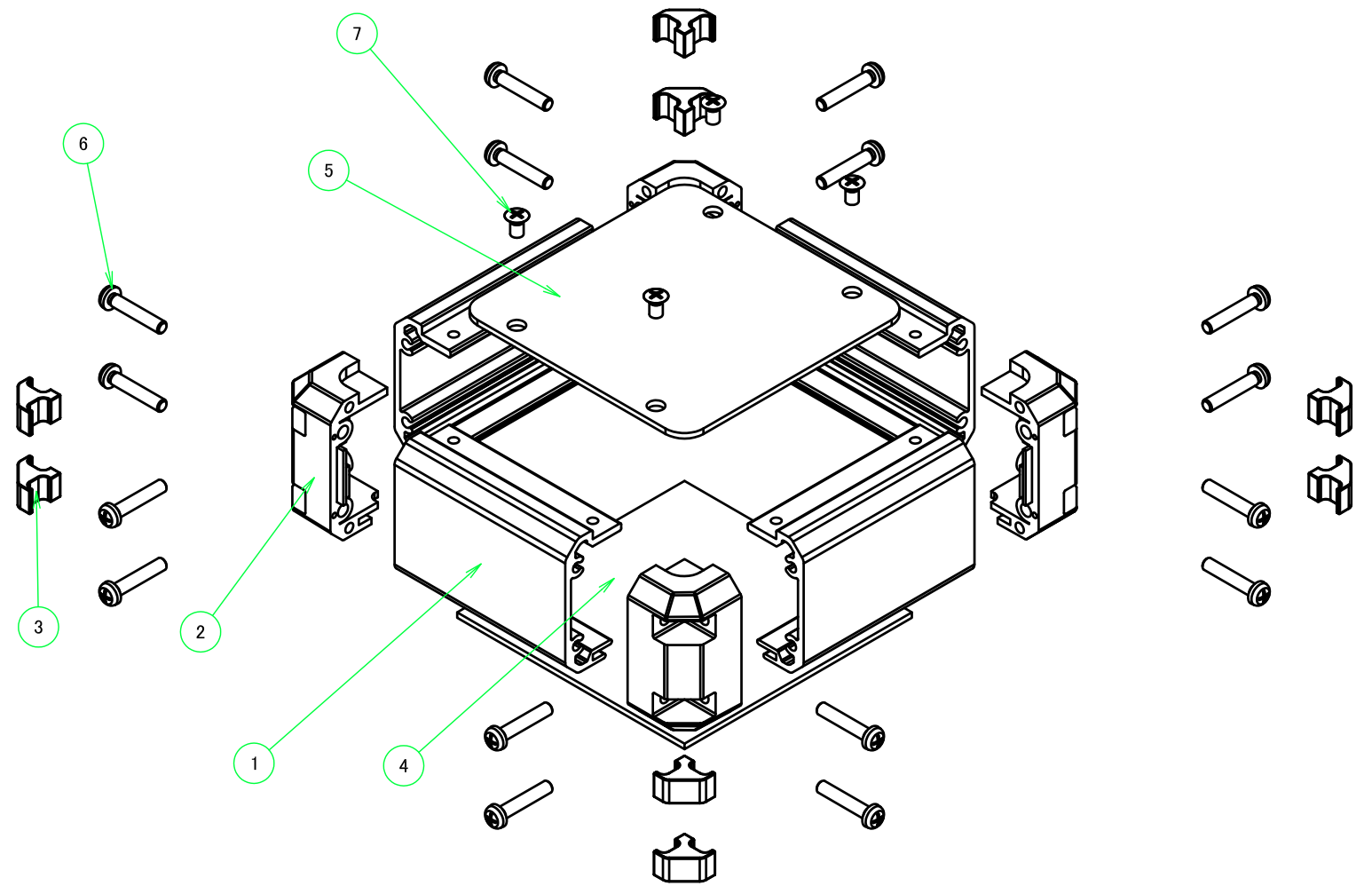

| 色仕様(型番末尾□) / Color Type(End of product number□) |               |               |                     |
|---|---------------|---------------|---------------------|
| 記号 / Code                                       | パネル / Panel   | フレーム / Freme  | コーナー / Corner       |
| G S   | シルバー / Silver | シルバー / Silver | ライトグレー / Light gray |
| B S   | シルバー / Silver | シルバー / Silver | ブラック / Black        |
| B X   | シルバー / Silver | ブラック / Black  | ブラック / Black        |
| B B   | ブラック / Black  | ブラック / Black  | ブラック / Black        |

|   |            |            |   |                   |
|---|------------|------------|---|-------------------|
| <b>株式会社タカチ電機工業</b><br>TAKACHI ELECTRONICS ENCLOSURE CO., LTD. |            |            | 品名/Title<br>コントロールボックス<br>ALUMINIUM CONTROL BOX | 尺度/Scale<br>1:1.5 |
| 承認/Approved   | 検図/Checked | 製図/Created | 型番/Product number<br>FC4-9-9□                   |                   |
| 中根  | 大江         | 常山         | 作成日/Date<br>2020/11/30                          | 1 / 7             |

外視図，内視図 / External View, Internal View

フレーム1側 / Frame1 side

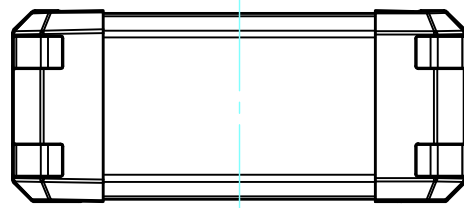

フレーム3側 / Frame3 side

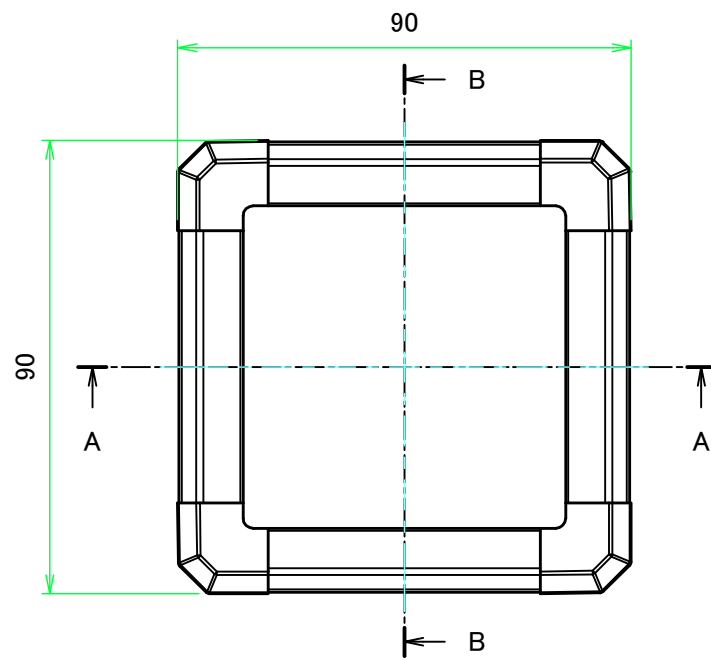
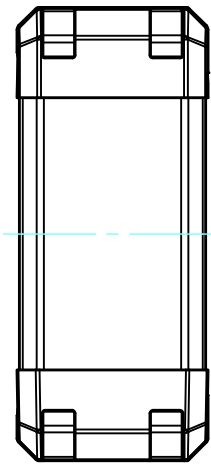

フレーム4側 / Frame4 side

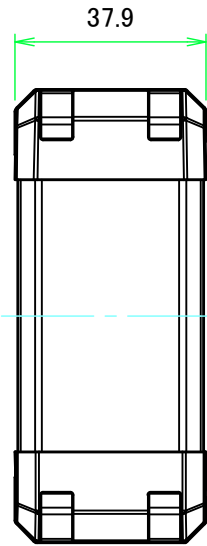

B-B (1:1.5)

有効寸法 / Max dim. 31.5

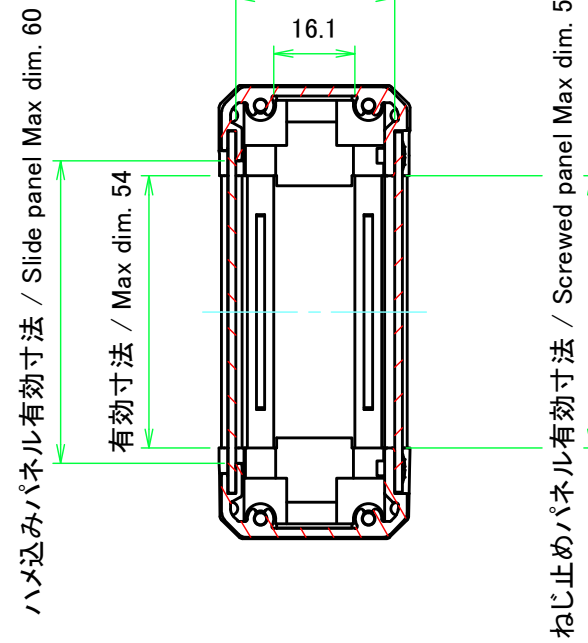

フレーム2側 / Frame2 side

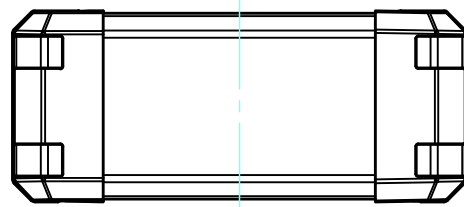

A-A (1:1.5)

ハメ込みパネル有効寸法 / Slide panel Max dim. 60

有効寸法 / Max dim. 54

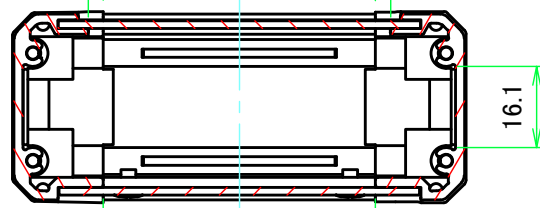

ねじ止めパネル有効寸法 / Screwed panel Max dim. 54

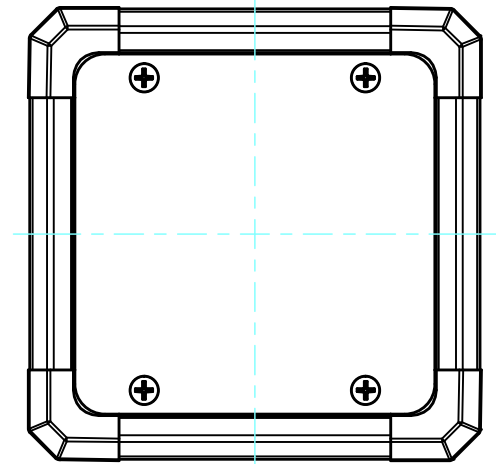

|  |            |   |                     |
|--|------------|---|---------------------|
| 株式会社タカチ電機工業<br>TAKACHI ELECTRONICS ENCLOSURE CO., LTD. |            | 品名/Title<br>コントロールボックス<br>ALUMINIUM CONTROL BOX | 尺度/Scale<br>1:1.5   |
| 承認/Approved  | 検図/Checked | 製図/Created                                      |                     |
|  | 大江         | 常山  | 作成日/Date 2017/05/09 |
|  |            |   | 2 / 7               |

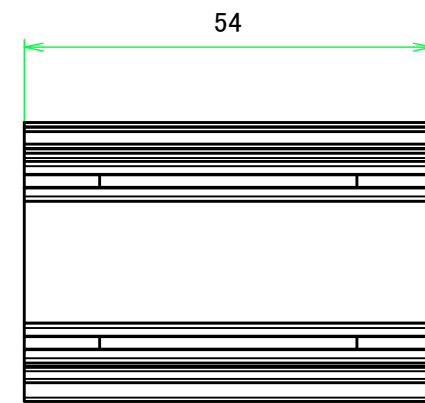
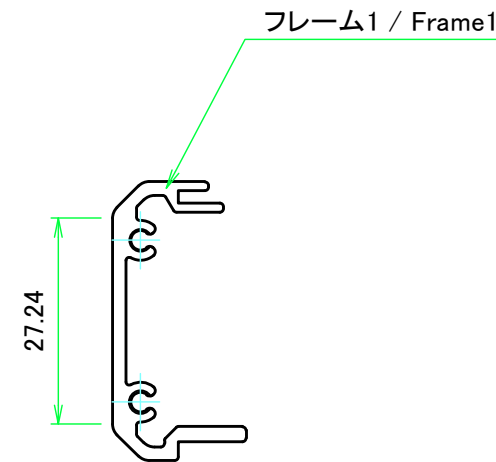
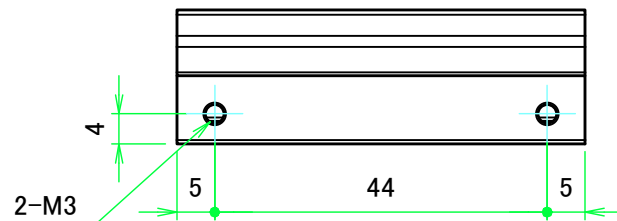
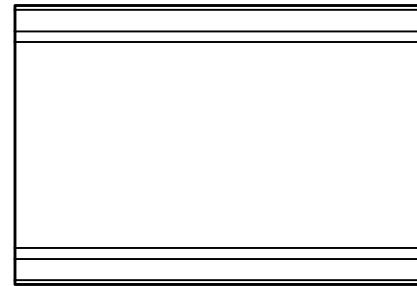
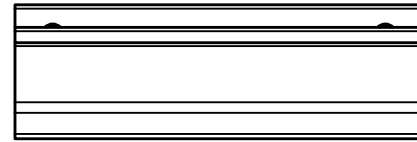
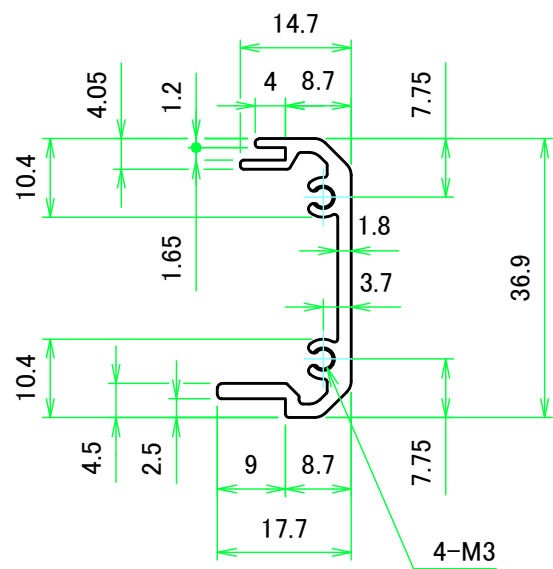

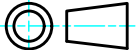
|  |            |                             |  |
|--|------------|-----------------------------|--|
|  株式会社タカチ電機工業<br>TAKACHI ELECTRONICS ENCLOSURE CO., LTD. |            | 品名/Title<br>フレーム1<br>Frame1 | <br>尺度/Scale<br>1:1 |
| 承認/Approved  | 検図/Checked | 製図/Created                  |  |
|  | 大江         | 常山                          | 作成日/Date 2017/05/09<br>3 / 7   |

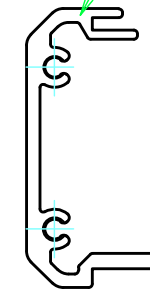
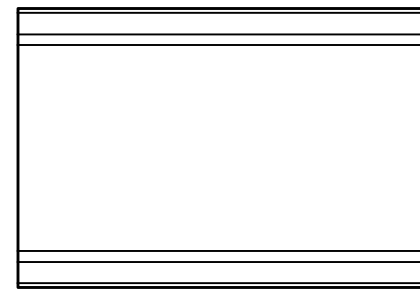
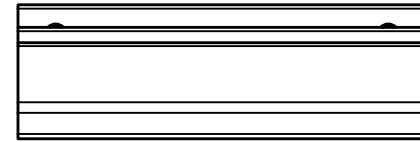
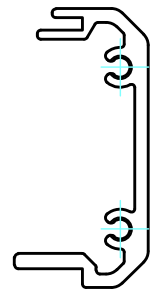

フレーム2 / Frame2

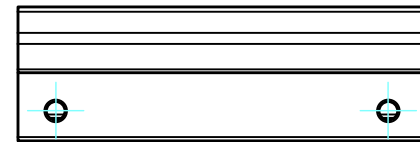
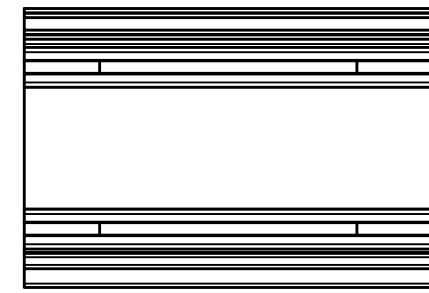

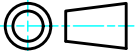
|  |                  |                                  |   |
|--|------------------|----------------------------------|---|
|  株式会社タカチ電機工業<br>TAKACHI ELECTRONICS ENCLOSURE CO., LTD. |                  | 品名/Title<br>フレーム2<br>Frame2      |  |
| 承認/Approved  | 検図/Checked<br>大江 | 製図/Created<br>常山                 | 尺度/Scale<br>1:1   |
|  |                  | 型番/Product number<br>H37.9 - W90 | 4 / 7   |
|  |                  | 作成日/Date<br>2017/05/09           |   |

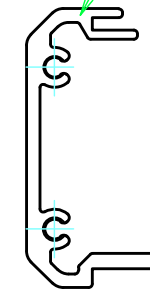
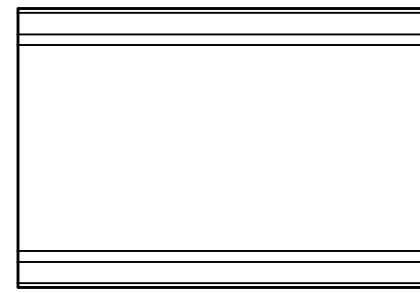
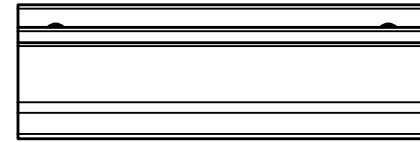
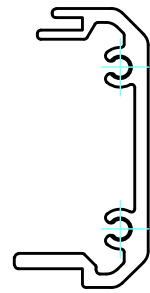

フレーム3 / Frame3

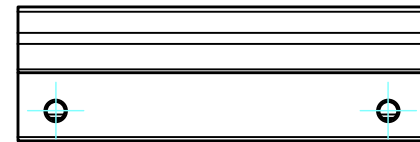
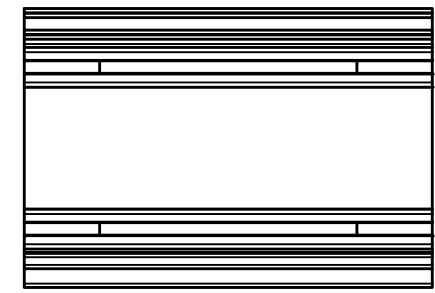

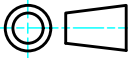
|  |            |                             |                                  |   |
|--|------------|-----------------------------|----------------------------------|---|
|  株式会社タカチ電機工業<br>TAKACHI ELECTRONICS ENCLOSURE CO., LTD. |            | 品名/Title<br>フレーム3<br>Frame3 |                                  |  |
| 承認/Approved  | 検図/Checked | 製図/Created                  | 型番/Product number<br>H37.9 - D90 |   |
|  | 大江         | 常山                          | 作成日/Date<br>2017/05/09           | 5 / 7   |

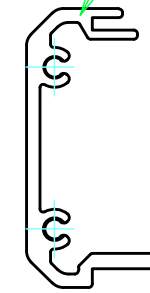
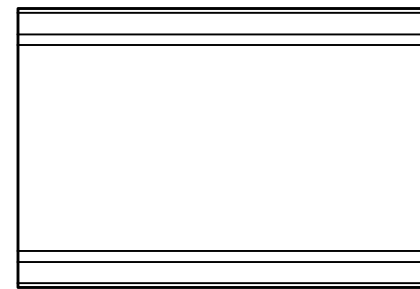
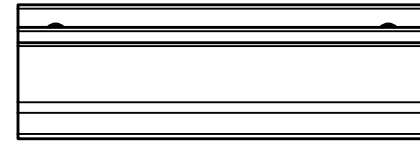
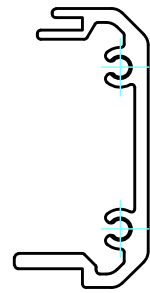

フレーム4 / Frame4

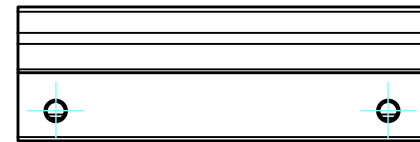
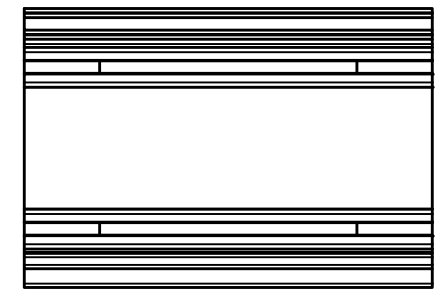

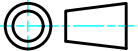
|  |            |                             |                                  |   |
|--|------------|-----------------------------|----------------------------------|---|
|  株式会社タカチ電機工業<br>TAKACHI ELECTRONICS ENCLOSURE CO., LTD. |            | 品名/Title<br>フレーム4<br>Frame4 |                                  |  |
| 承認/Approved  | 検図/Checked | 製図/Created                  | 型番/Product number<br>H37.9 - D90 |   |
|  | 大江         | 常山                          | 作成日/Date<br>2017/05/09           | 6 / 7   |

ハメ込みパネル / Slide panel

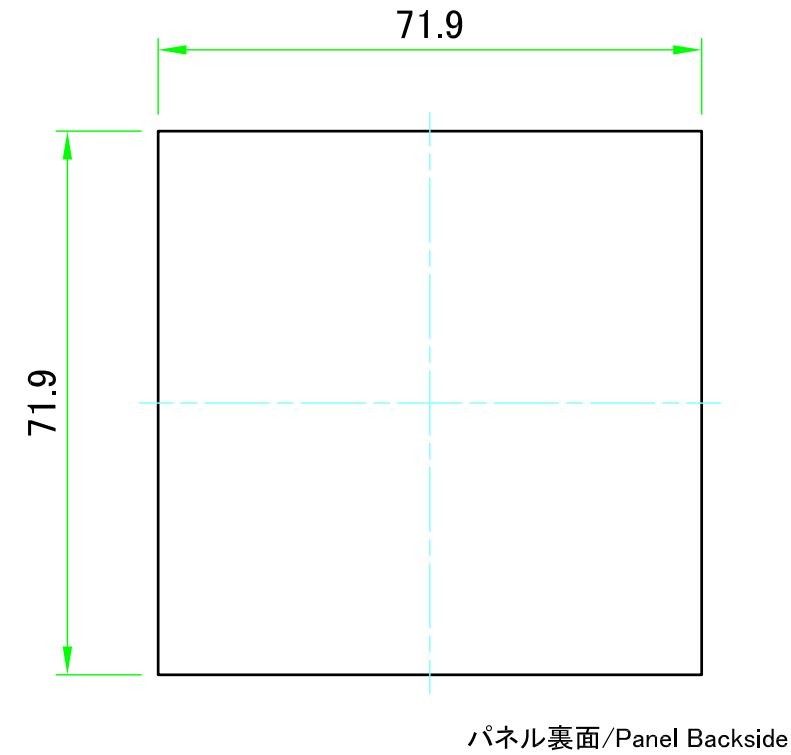
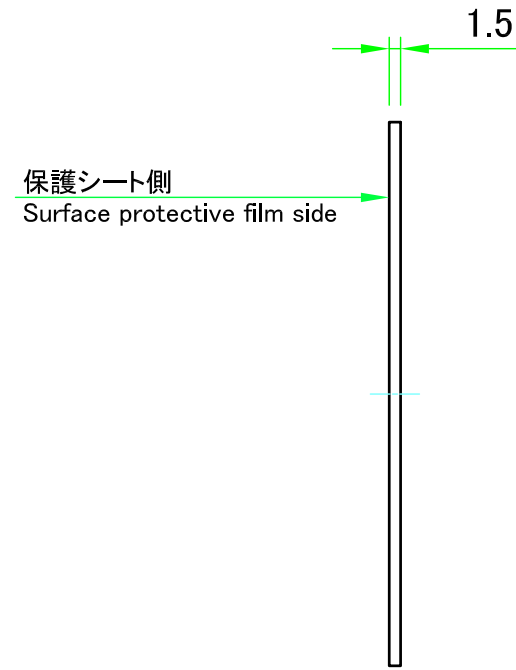
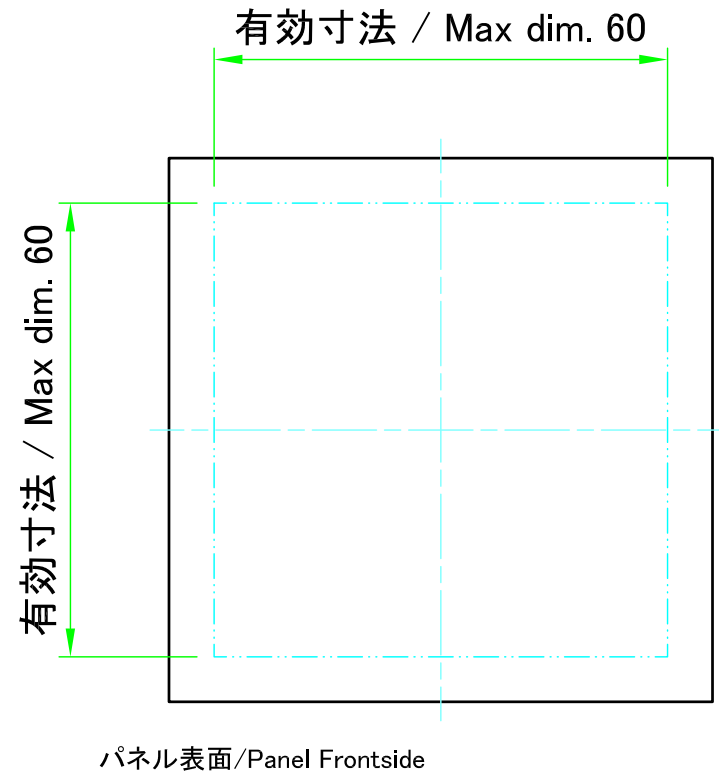

ねじ止めパネル / Screwed panel

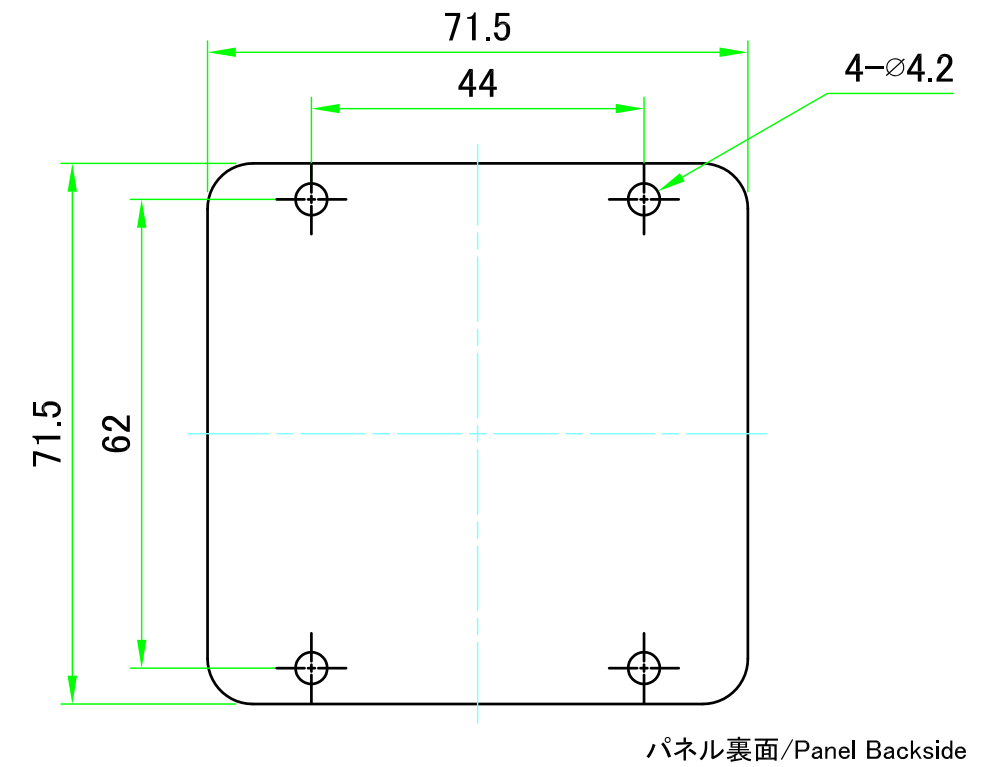
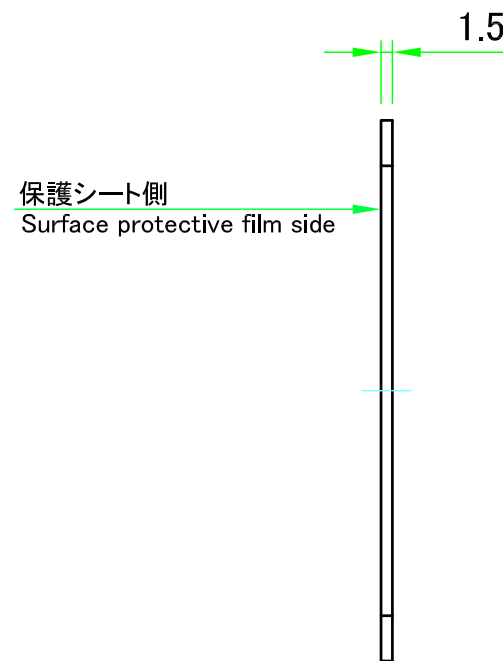
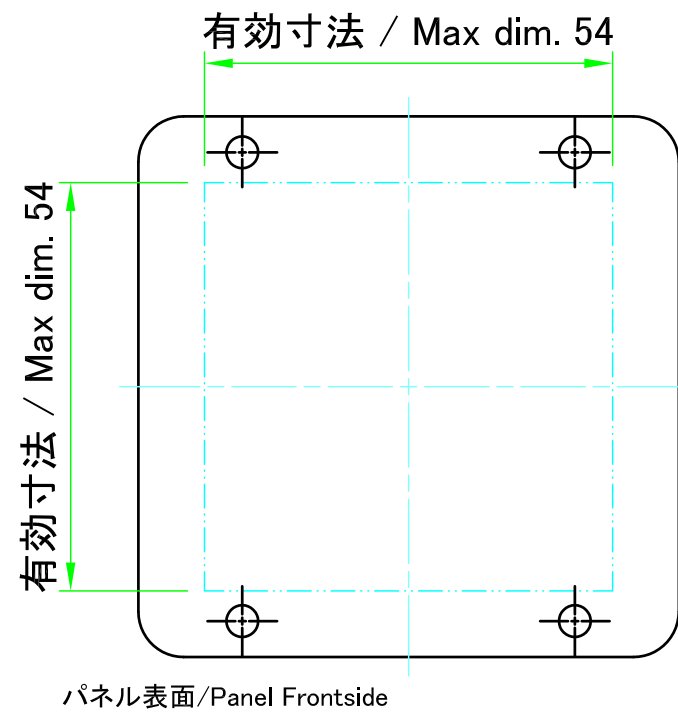

|  |              |              |                                  |                   |
|--|--------------|--------------|----------------------------------|-------------------|
| 株式会社タカチ電機工業<br>TAKACHI ELECTRONICS ENCLOSURE CO., LTD. |              |              | 品名 / Title<br>パネル<br>Panel       | 尺度 / Scale<br>1:1 |
| 承認 / Approved  | 検図 / Checked | 製図 / Created | 型番 / Product number<br>W90 - D90 |                   |
| 中根   | 大江           | 常山           | 作成日 / Date<br>2020/07/08         | 7 / 7             |