

構成内容 / Components				
No.	名称 / Part name	数量 / Pcs	材質 / Material	色・表面処理 / Color・Finish
1	フレーム Frame	4	アルミ押出材 A6063S-T5 Extruded aluminium A6063S-T5	シルバー、ブラック・アルマイト & クリア塗装 Silver, black • Anodized & clear coated
2	コーナーブロック Corner block	4	ABS樹脂 UL94HB ABS UL94HB	ライトグレー、ブラック Light gray, Black
3	コーナーキャップ / Blind plug	8	エラストマ / TPE	ライトグレー、ブラック / Light gray, Black
4	ハメ込みパネル / Slide panel	1	アルミ板 / Aluminium A1100P t=1.5 アルミ板 / Aluminium A1100P t=1.5	シルバーアルマイト / Silver • Anodized ブラック・塗装 / Black • Painted
5	ねじ止めパネル / Screwed panel	1	アルミ板 / Aluminium A1100P t=1.5 アルミ板 / Aluminium A1100P t=1.5	シルバーアルマイト / Silver • Anodized ブラック・塗装 / Black • Painted
6	取付ビス(M3 x 15 ナベ) Screw(M3 - 15 Pan head)	16	鉄 Steel	三価クロメート Trivalent chromate
7	取付ビス(M3 x 5 座付丸皿) Screw(M3 - 5 Slotted raised countersunk)	6	鉄 Steel	ニッケルメッキ、三価黒クロメート Nickel plated, Black trivalent chromate

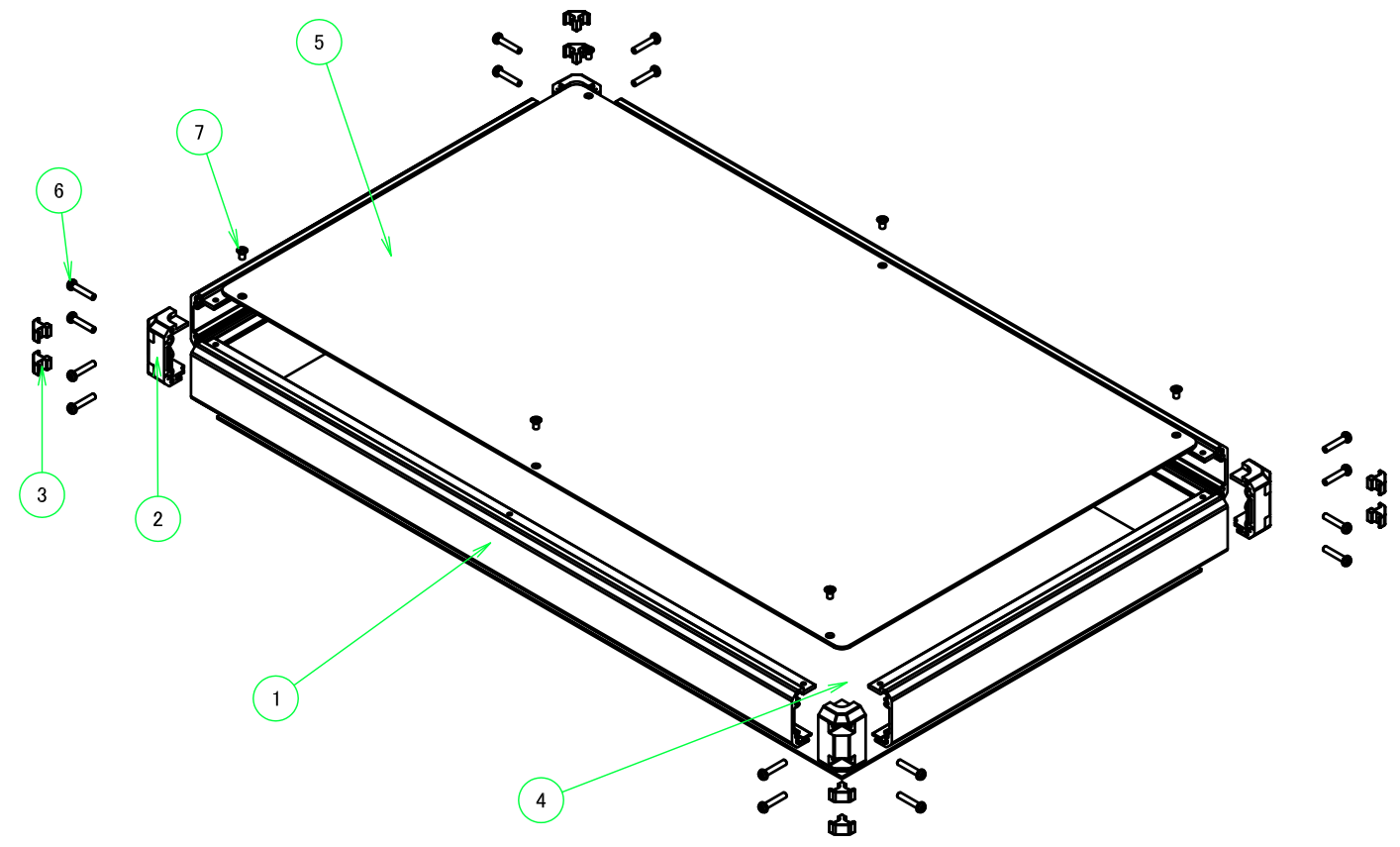
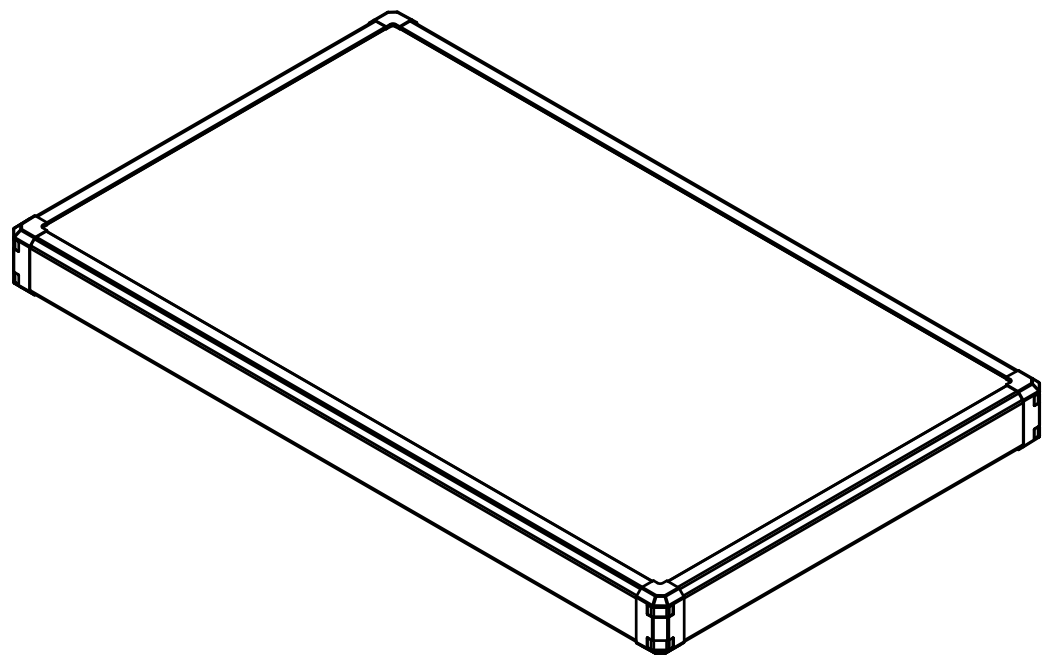
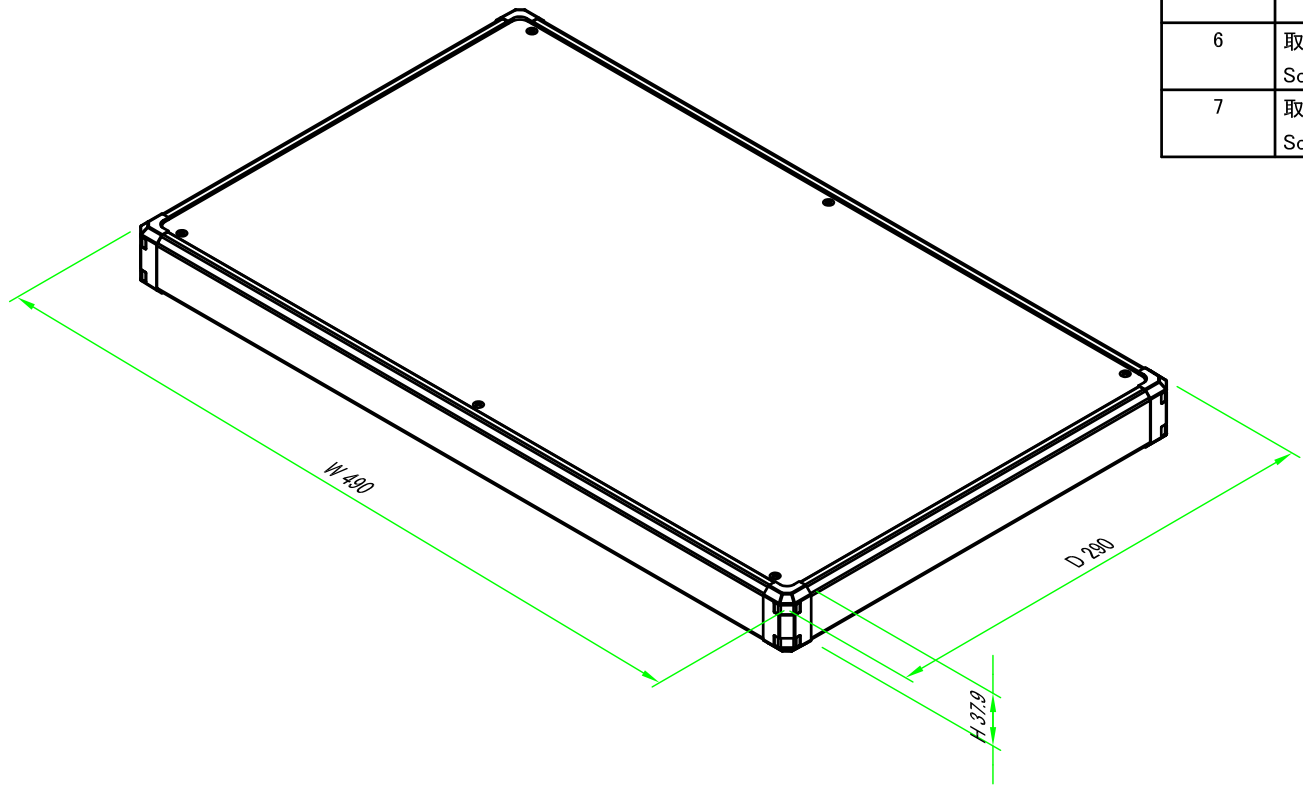

色仕様(型番末尾□) / Color Type(End of product number□)			
記号 / Code	パネル / Panel	フレーム / Freme	コーナー / Corner
G S	シルバー / Silver	シルバー / Silver	ライトグレー / Light gray
B S	シルバー / Silver	シルバー / Silver	ブラック / Black
B X	シルバー / Silver	ブラック / Black	ブラック / Black
B B	ブラック / Black	ブラック / Black	ブラック / Black

<b>株式会社タカチ電機工業</b> TAKACHI ELECTRONICS ENCLOSURE CO., LTD.			品名/Title <b>コントロールボックス</b> ALUMINIUM CONTROL BOX	尺度/Scale 1:4
承認/Approved 中根	検図/Checked 大江	製図/Created 常山	型番/Product number <b>FC4-49-29□</b>	
			作成日/Date 2020/11/30	1 / 7

外視図, 内視図 / External View, Internal View

フレーム1側 / Frame1 side



フレーム3側 / Frame3 side

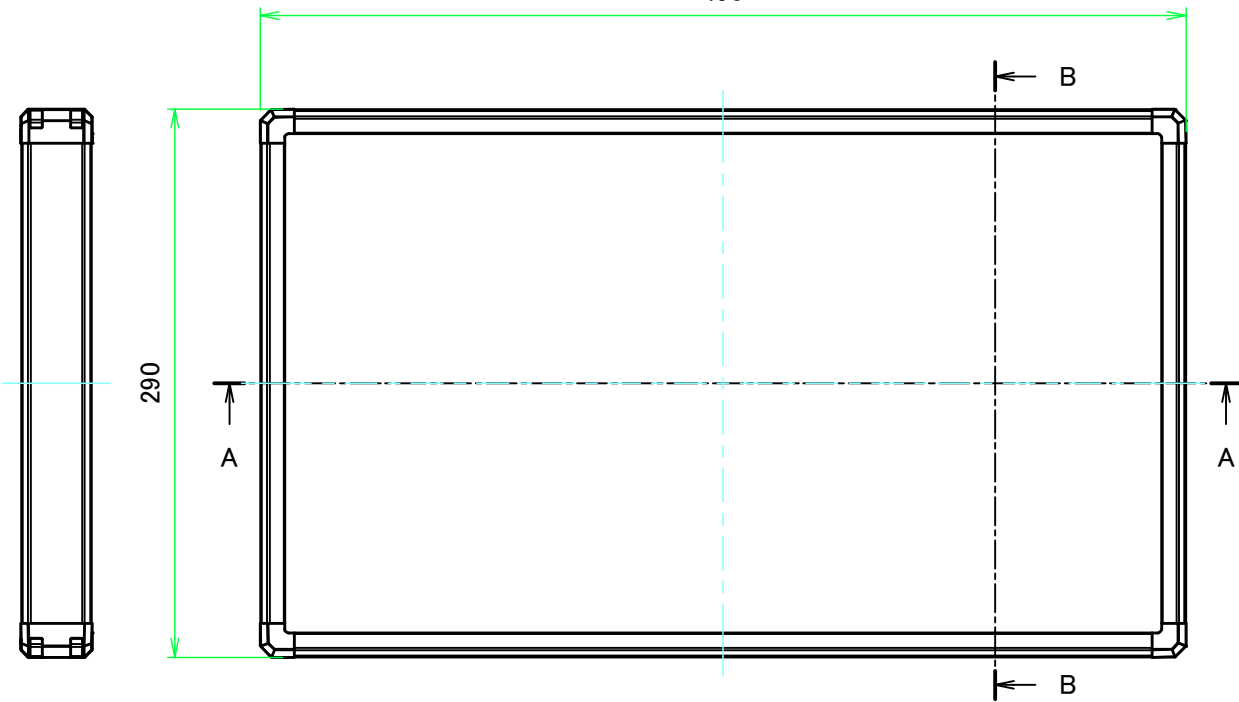

フレーム4側 / Frame4 side

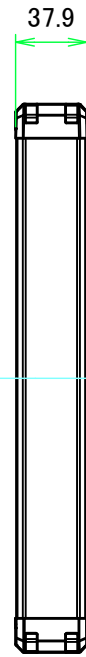

B-B (1:4)

有効寸法 / Max dim. 31.5

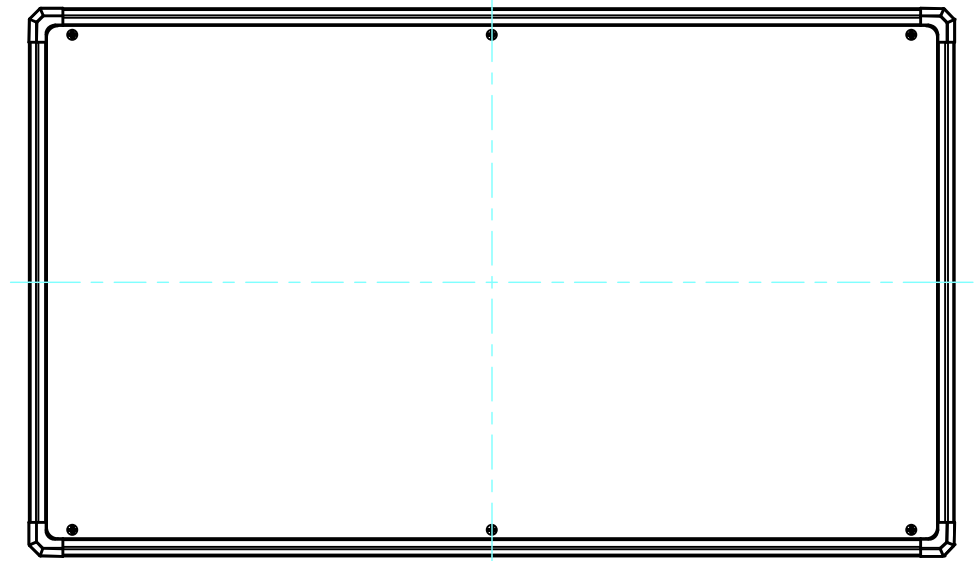
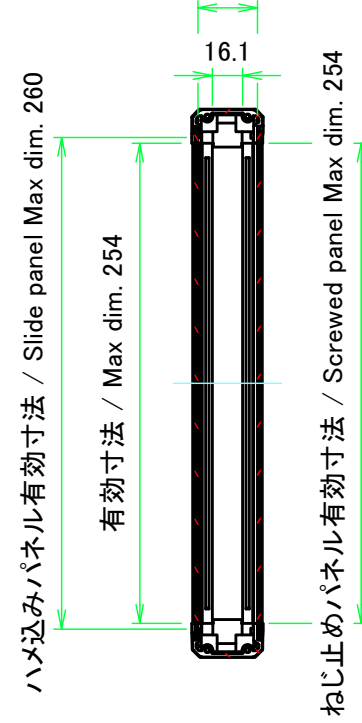

フレーム2側 / Frame2 side



A-A (1:4)

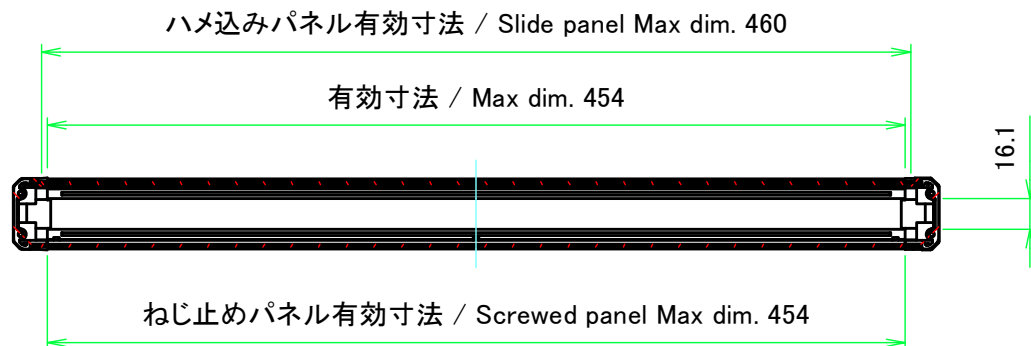

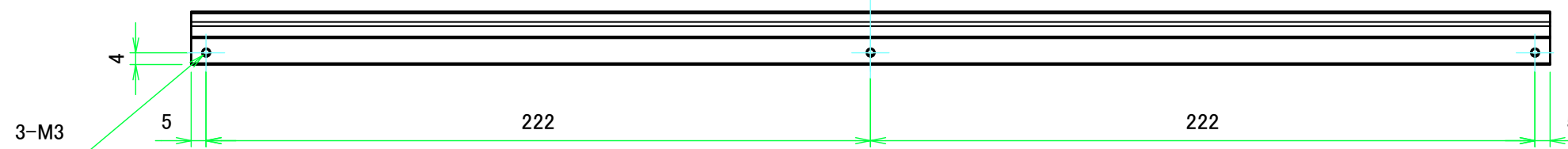
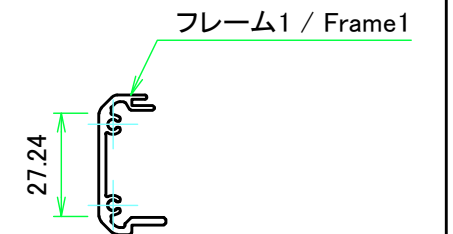
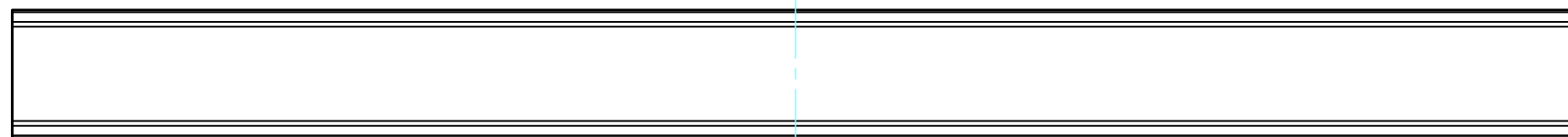
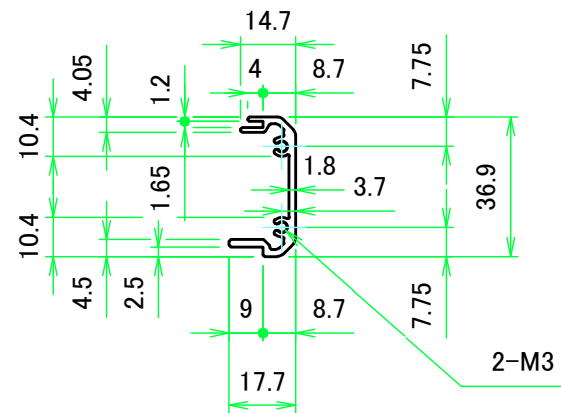
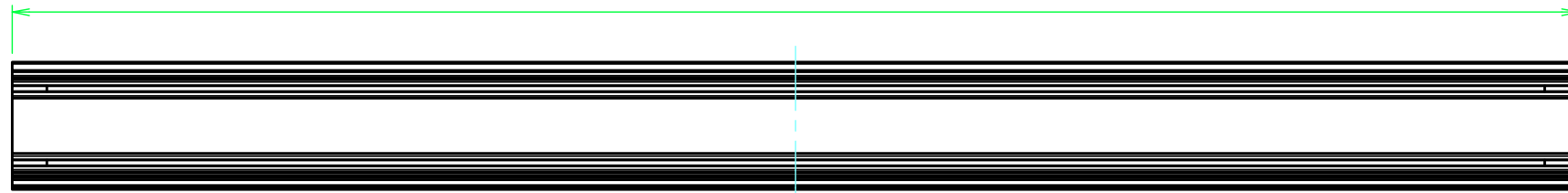

株式会社タカチ電機工業 TAKACHI ELECTRONICS ENCLOSURE CO., LTD.			品名/Title コントロールボックス ALUMINIUM CONTROL BOX	尺度/Scale 1:4
承認/Approved	検図/Checked	製図/Created	型番/Product number FC4-49-29□	
	大江	常山	作成日/Date 2018/02/22	2 / 7

454

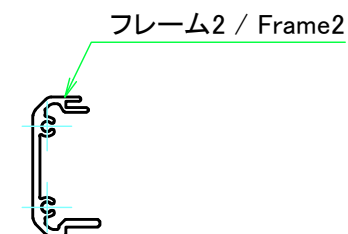
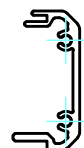
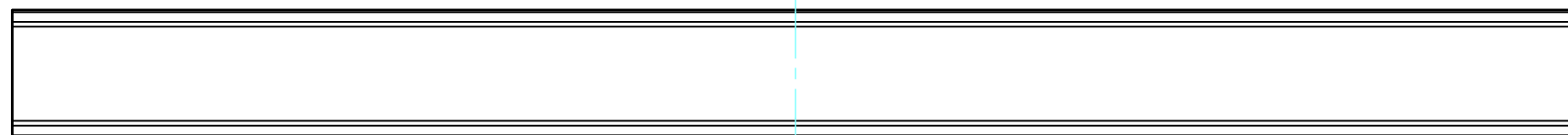
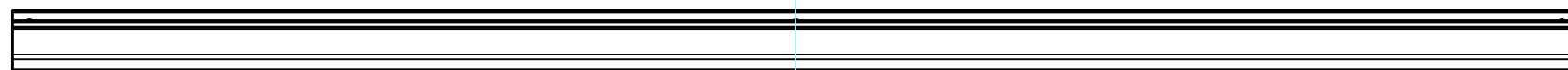
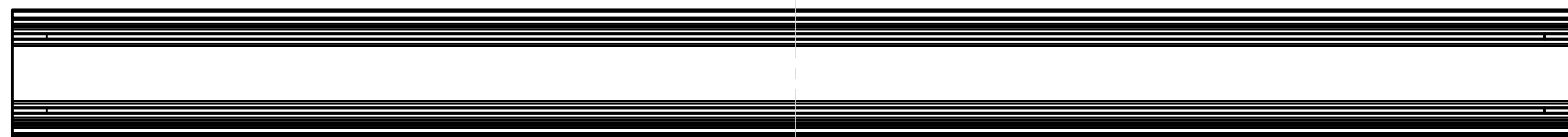

<b>TAKACHI</b> 株式会社タカチ電機工業 TAKACHI ELECTRONICS ENCLOSURE CO., LTD.		品名/Title フレーム1 Frame1	
承認/Approved	検図/Checked 大江	製図/Created 常山	
		型番/Product number H37.9 - W490	3 / 7
		作成日/Date 2018/02/22	



 株式会社タカチ電機工業 TAKACHI ELECTRONICS ENCLOSURE CO., LTD.		品名/Title フレーム2 Frame2	
承認/Approved	検図/Checked 大江	製図/Created 常山	型番/Product number H37.9 - W490
		作成日/Date 2018/02/22	尺度/Scale 1:2
			4 / 7

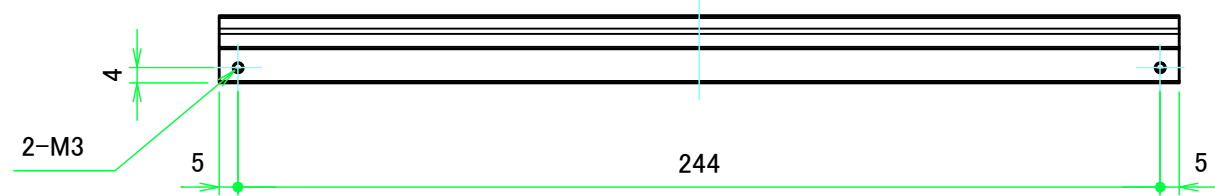
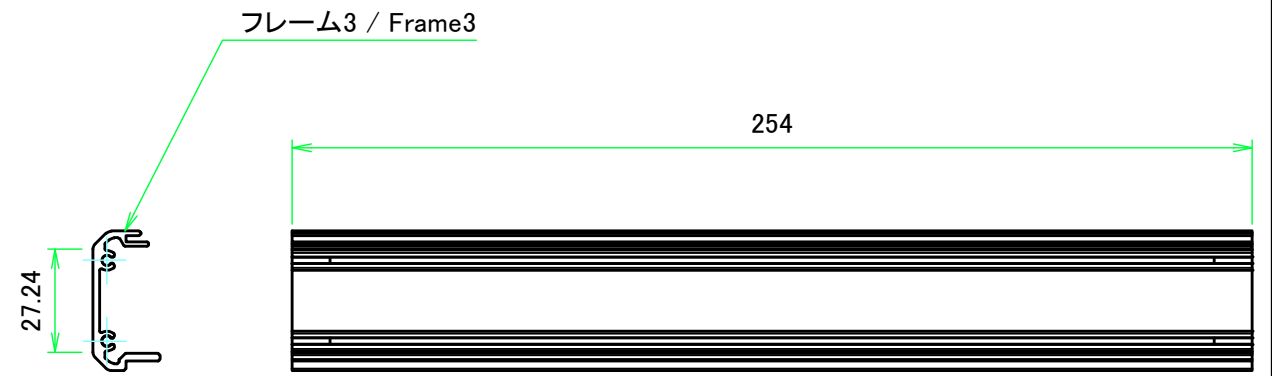
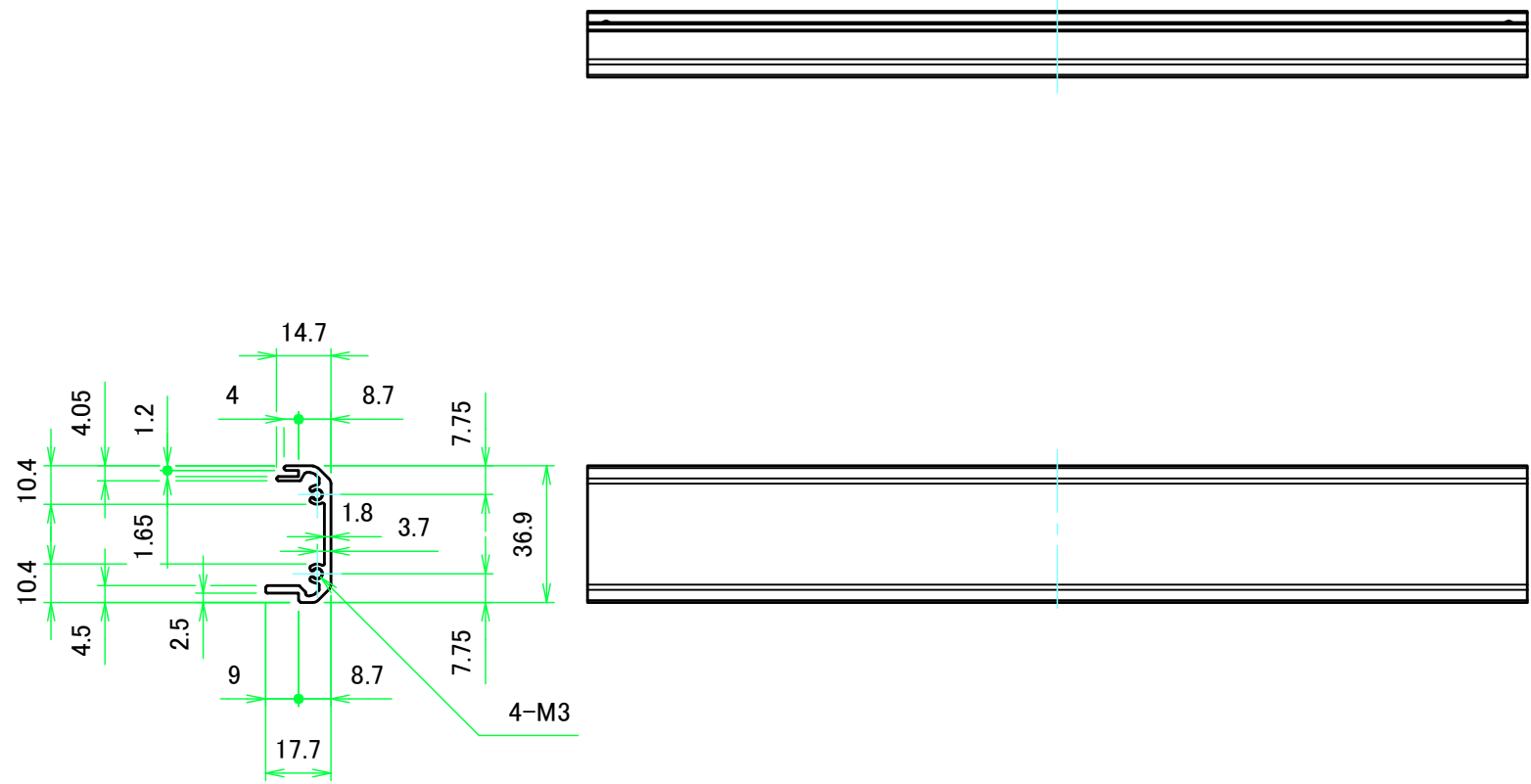

株式会社タカチ電機工業 TAKACHI ELECTRONICS ENCLOSURE CO., LTD.		品名/Title フレーム3 Frame3	尺度/Scale 1:2
承認/Approved	検図/Checked	製図/Created	
	大江	常山	作成日/Date 2018/02/22
			5 / 7

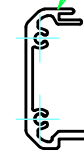
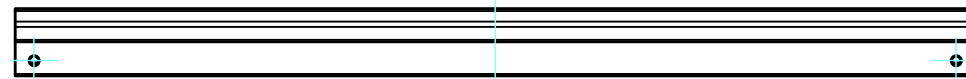

フレーム4 / Frame4

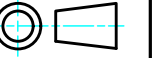

 株式会社タカチ電機工業 TAKACHI ELECTRONICS ENCLOSURE CO., LTD.		品名/Title フレーム4 Frame4		
承認/Approved	検図/Checked	製図/Created	型番/Product number H37.9 - D290	
	大江	常山	作成日/Date 2018/02/22	6 / 7

ハメ込みパネル / Slide panel

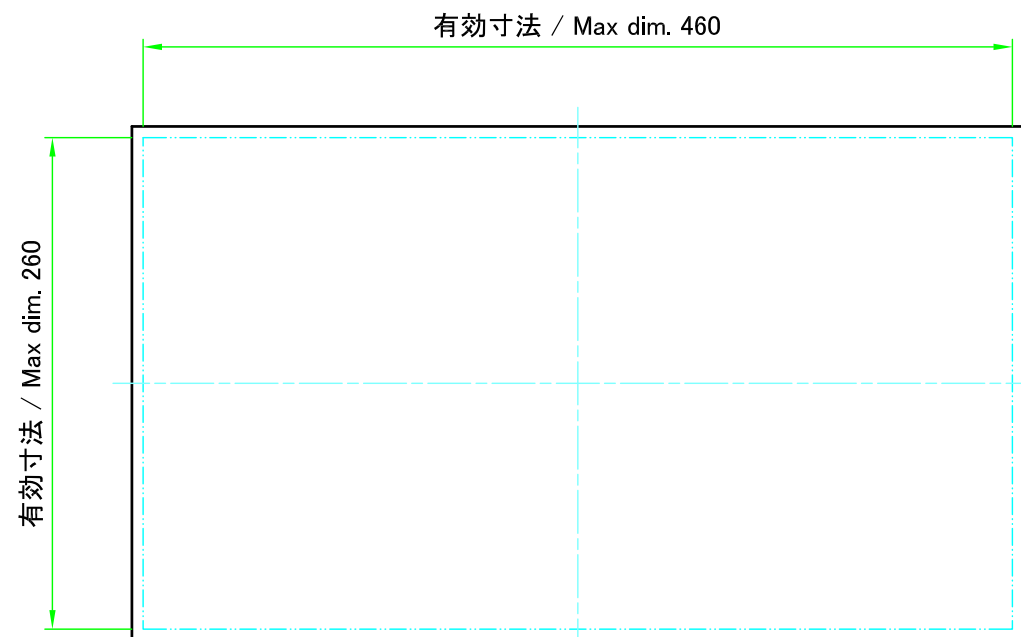

パネル表面/Panel Frontside

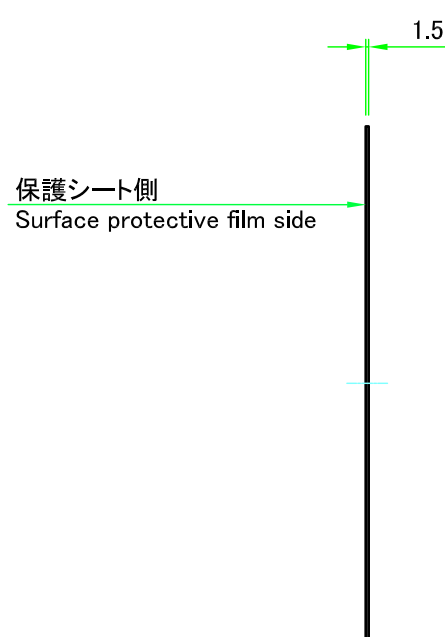

パネル裏面/Panel Backside

ねじ止めパネル / Screwed panel

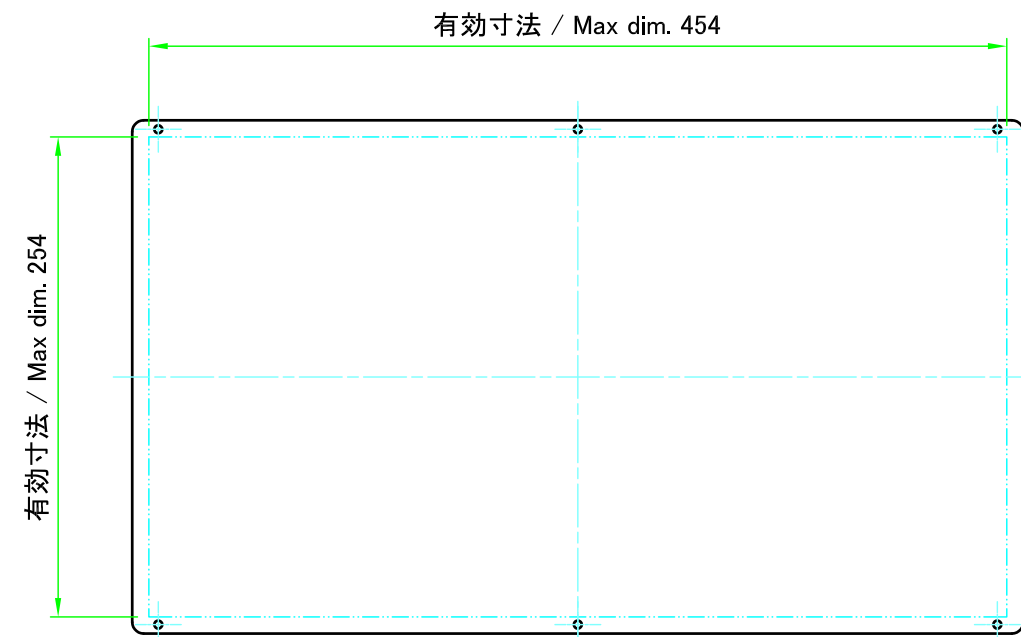

パネル表面/Panel Frontside

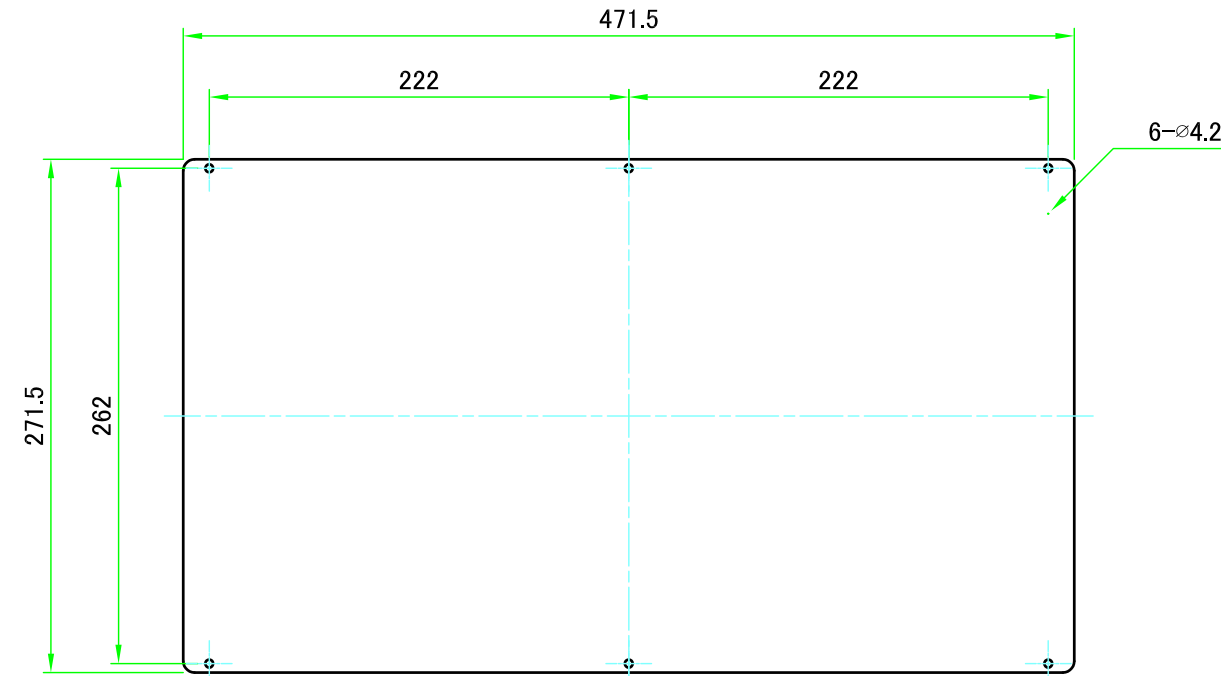
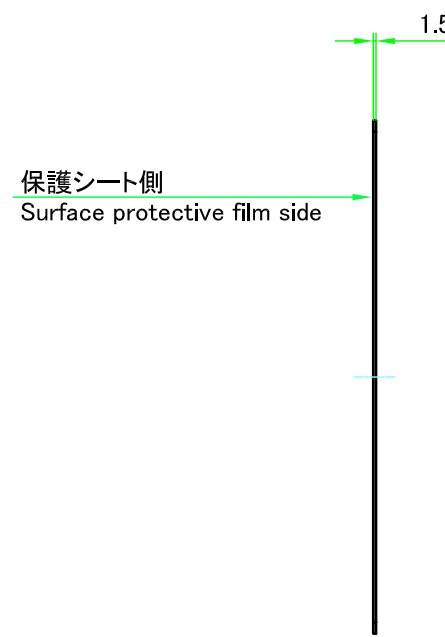

パネル裏面/Panel Backside

株式会社タカチ電機工業 TAKACHI ELECTRONICS ENCLOSURE CO., LTD.			品名/Title パネル Panel	尺度/Scale 1:4
承認/Approved	検図/Checked	製図/Created	型番/Product number W490 - D290	
中根	大江	常山	作成日/Date 2020/07/09	7 / 7