

ケース型番 / Product Number

EXPFS 113 - 42 -

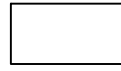

D

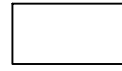

色記号
Color Code

寸法制限範囲 / Dimension limit range

D = 40 ~ 500

構成内容 / Components				
No.	名称 / Part name	数量 / Pcs	材質 / Material	色・表面処理 / Color・Finish
1	パネル / Panel	2	アルミ板 / Aluminium A1100 t=1.5	シルバーアルマイト, ブラックアルマイト / Silver, Black Anodized
2	上カバー / Top cover	1	アルミ押出材 / Extruded aluminium A6063S-T5	シルバーアルマイト, ブラックアルマイト / Silver, Black Anodized
3	下カバー / Bottom cover	1	アルミ押出材 / Extruded aluminium A6063S-T5	シルバーアルマイト, ブラックアルマイト / Silver, Black Anodized
4	フランジフレーム / Flanged frame	2	PC+ABS樹脂 / Polycarbonate-ABS UL94V-0	塗装無: ブラック, グレー / Black, Gray ・ Unpainted 塗装付: ネイビー / Navy ・ Painted
5	取付ビス(M2.5×8 六角穴付) / Screw	8	ステンレス / Stainless steel	無処理 / Unfinished

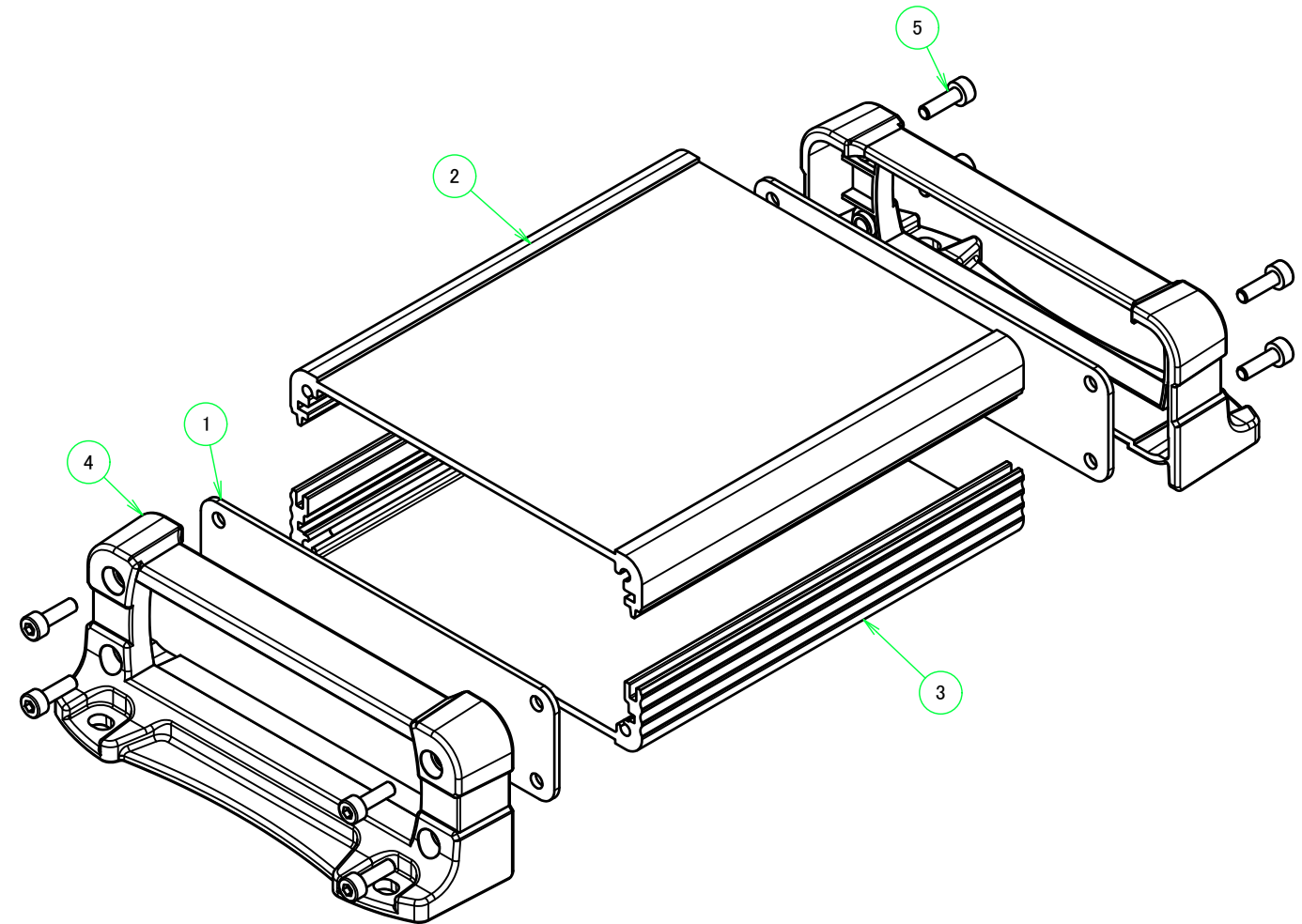
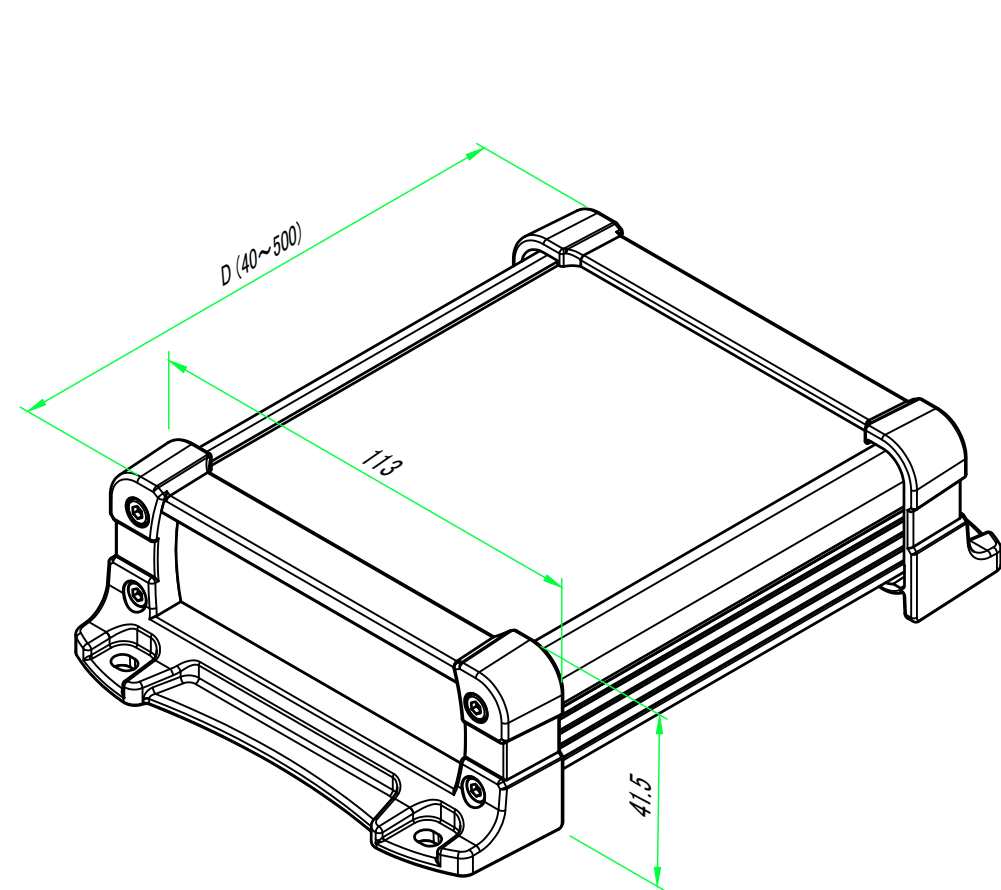

色仕様(型番末尾□□) / Color type (End of product number□□)

記号 / Code	上下カバー / Cover	フレーム / Flanged frame
SB	シルバー / Silver	ブラック / Black
SG	シルバー / Silver	グレー / Gray
SN	シルバー / Silver	ネイビー / Navy
BB	ブラック / Black	ブラック / Black
BG	ブラック / Black	グレー / Gray
BN	ブラック / Black	ネイビー / Navy

株式会社タカチ電機工業 <small>TAKACHI ELECTRONICS ENCLOSURE CO., LTD.</small>			品名/Title フランジ足付アルミパネルフリーサイズケース FLANGED ALUMINIUM PANEL CASE -CUSTOM LENGTH-	尺度/Scale 1 : 1.5
承認/Approved	検図/Checked	製図/Created	型番/Product number EXPFS113-42-□□□	
中根	大江	岡本	作成日/Date 2019/07/19	1 / 5

B-B (1:2.5)

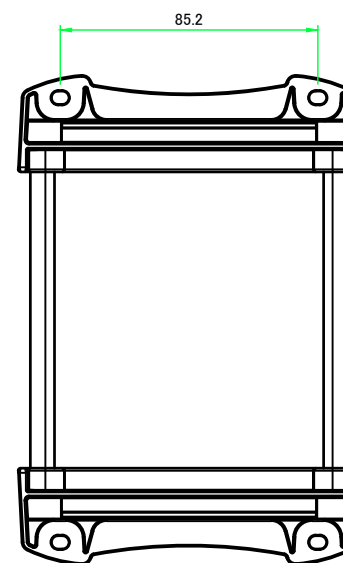
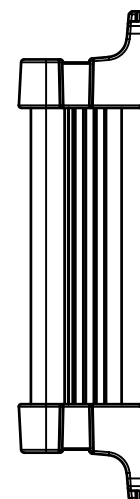
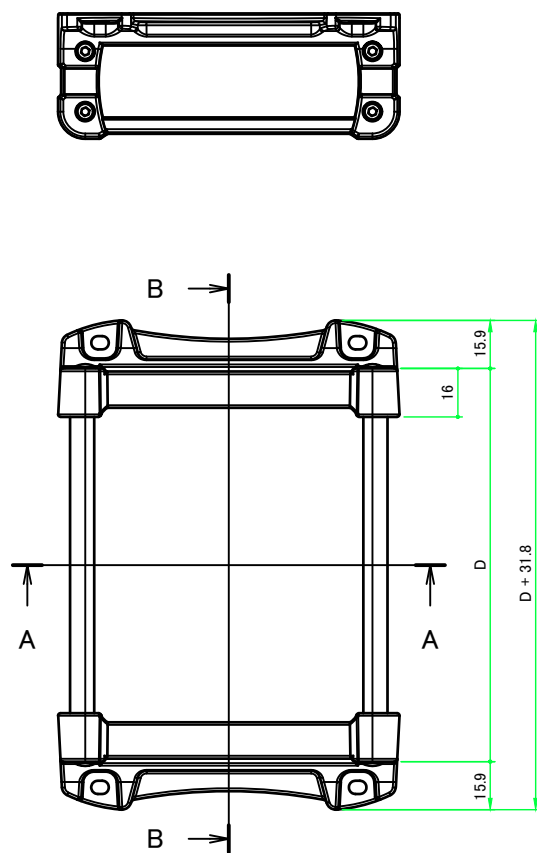
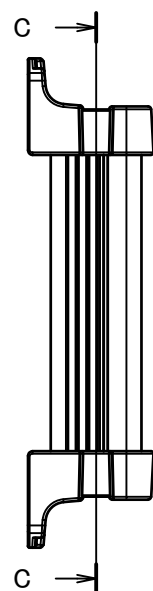
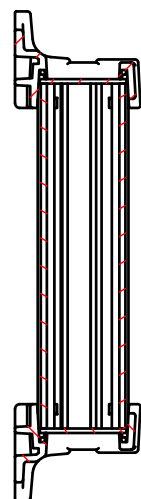

C-C (1:2.5)

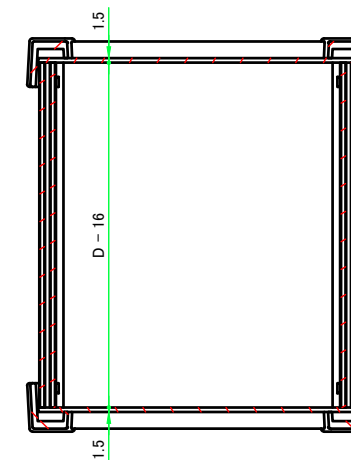

4-M3 六角穴付ボルト
4-M3 Countersunk hole

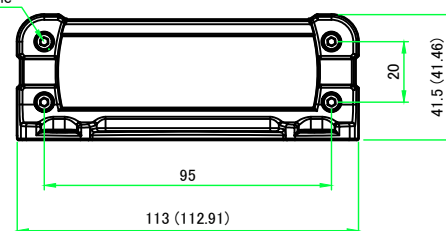

A-A (1:2.5)

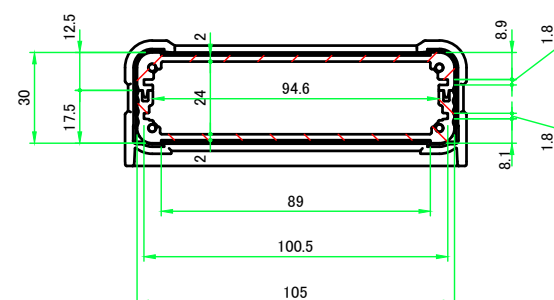

株式会社タカチ電機工業 TAKACHI ELECTRONICS ENCLOSURE CO., LTD.		品名/Title フランジ足付アルミパネルフリーサイズケース FLANGED ALUMINIUM PANEL CASE -CUSTOM LENGTH-	尺度/Scale 1:2.5
承認/Approved	検図/Checked	製図/Created	
中根	大江	岡本	作成日/Date 2019/07/19
			2 / 5

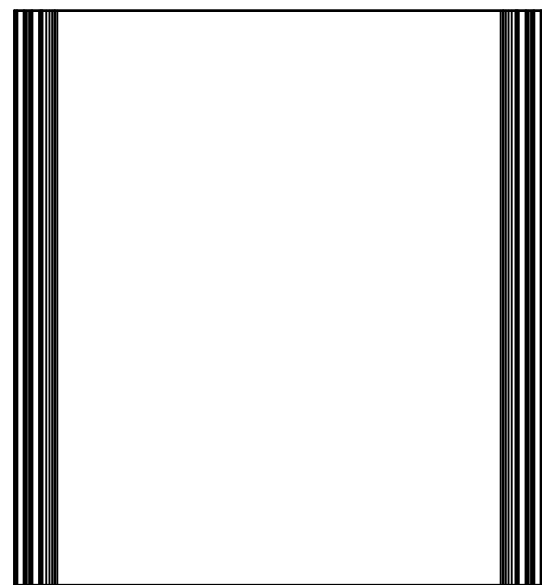
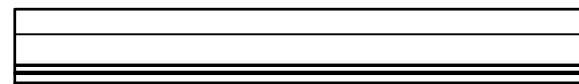
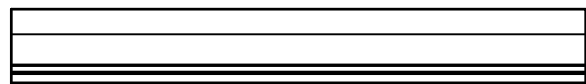
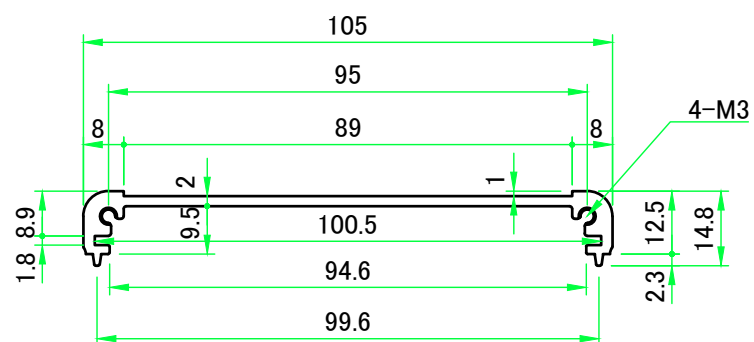
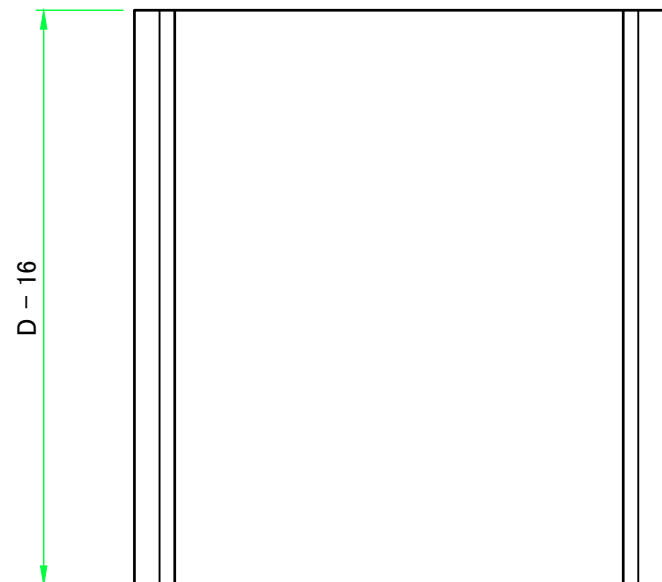

株式会社タカチ電機工業 TAKACHI ELECTRONICS ENCLOSURE CO., LTD.			品名/Title 上カバー TOP COVER	尺度/Scale 1 : 1.5
承認/Approved	検図/Checked	製図/Created	型番/Product number W105-D	
中根	大江	岡本	作成日/Date 2019/07/19	3 / 5

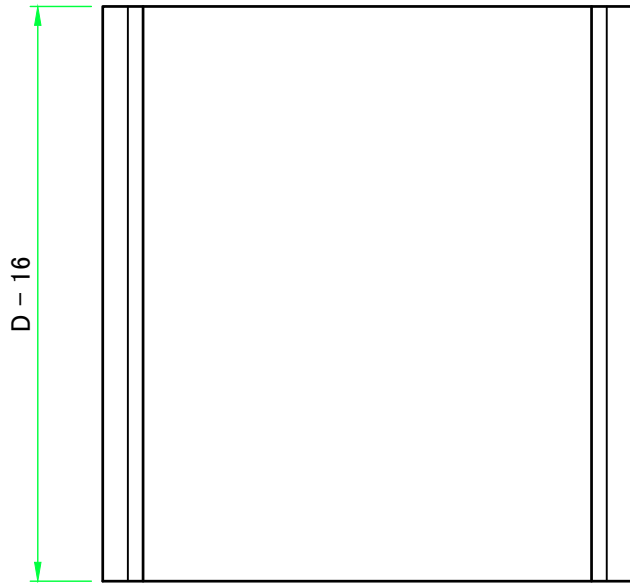
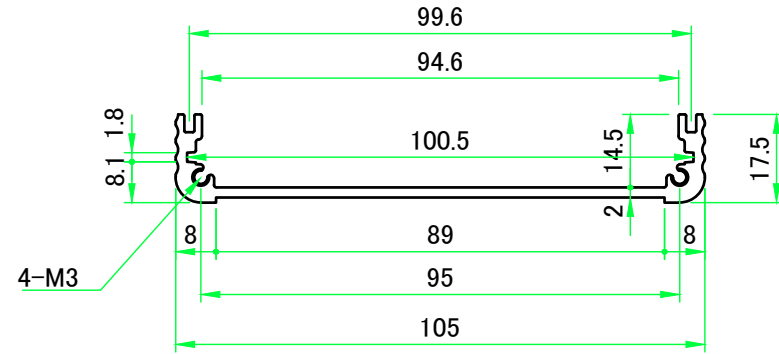
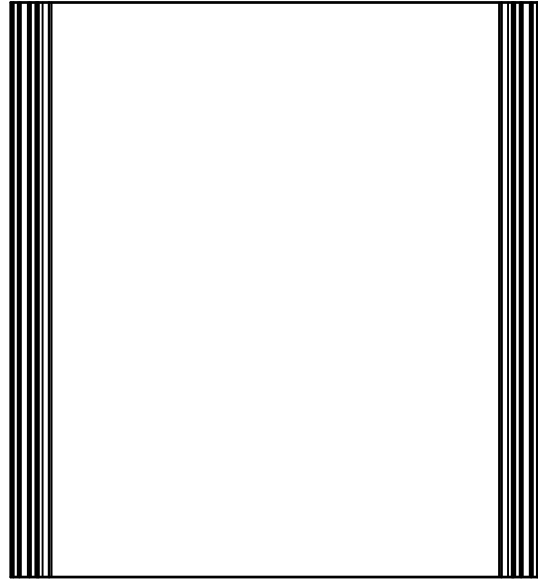
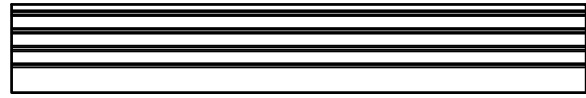

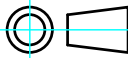
 株式会社タカチ電機工業 TAKACHI ELECTRONICS ENCLOSURE CO., LTD.			品名/Title 下カバー BOTTOM COVER	 尺度/Scale 1 : 1.5
承認/Approved 中根	検図/Checked 大江	製図/Created 岡本	型番/Product number W105-H30-D 作成日/Date 2019/07/19	

A-A (1:1)

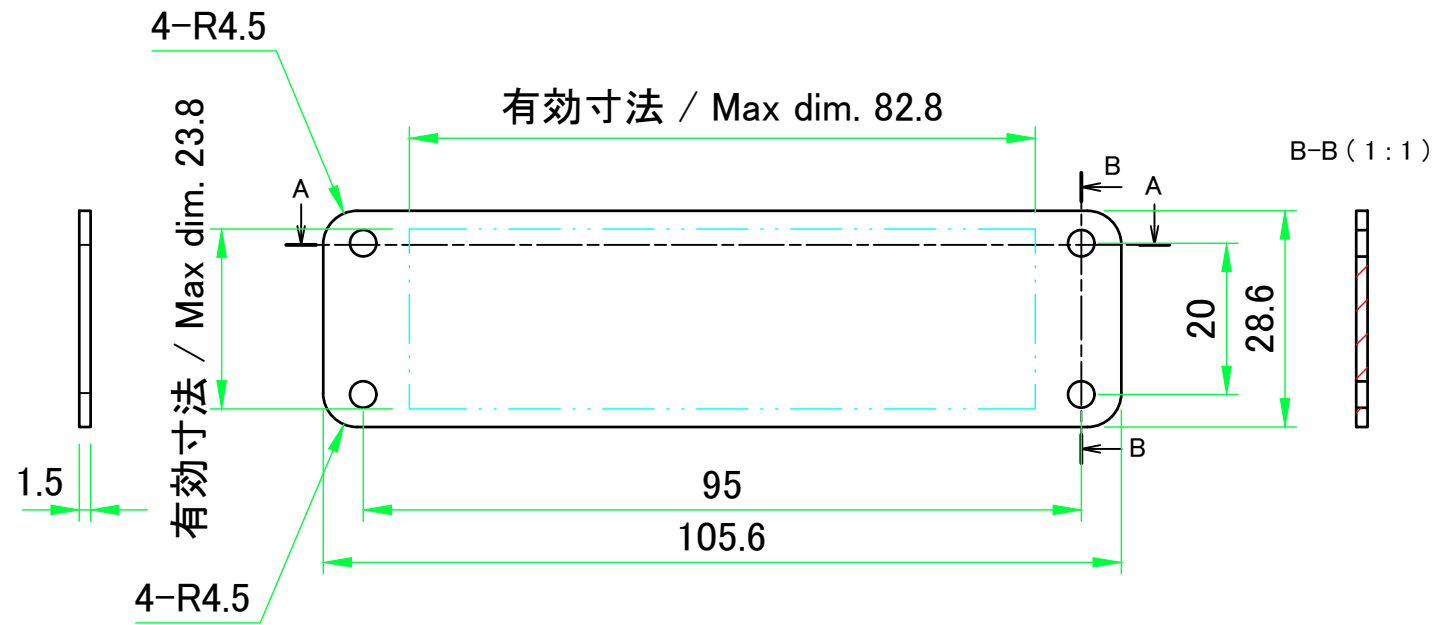

B-B (1:1)

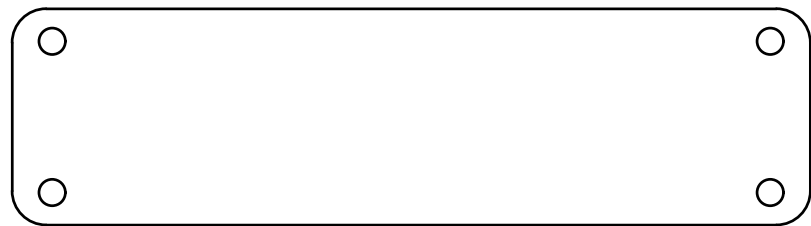
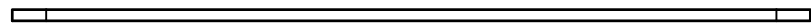

C-C (1:1)

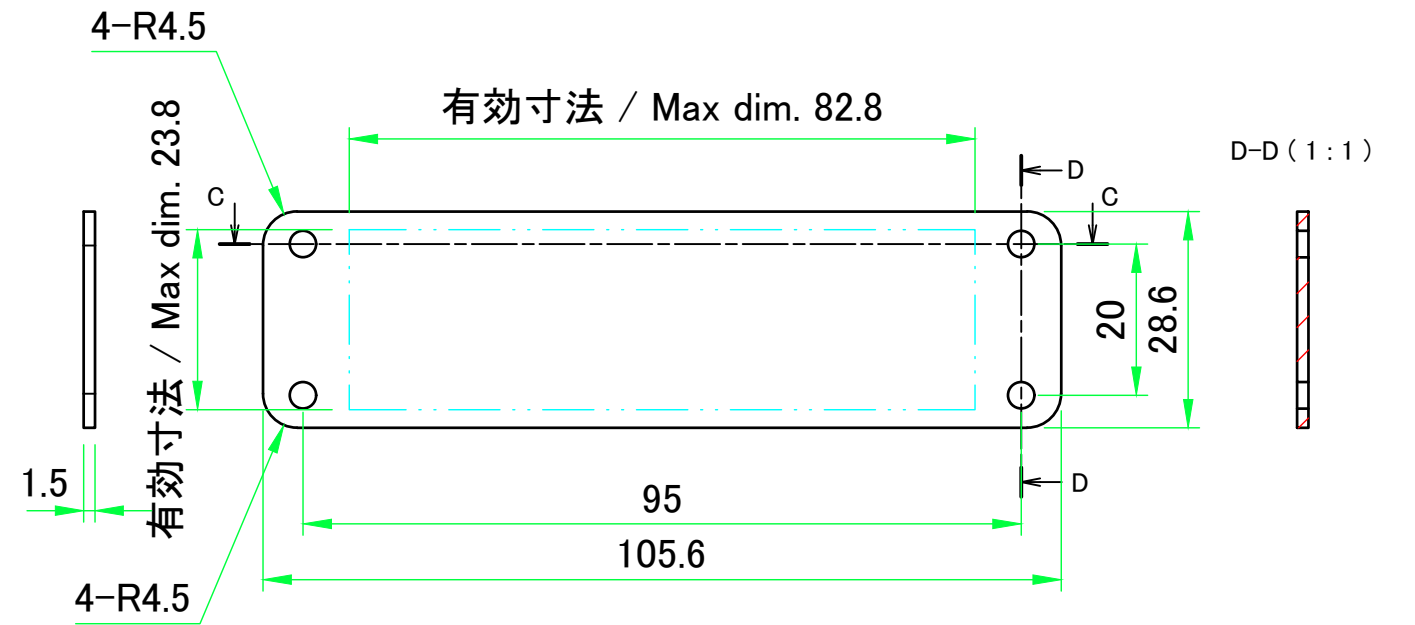

D-D (1:1)

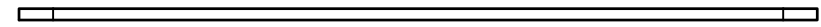

株式会社タカチ電機工業 TAKACHI ELECTRONICS ENCLOSURE CO., LTD.			品名/Title パネル PANEL	尺度/Scale 1:1
承認/Approved	検図/Checked	製図/Created	型番/Product number W105 - H30	
中根	岡本	大江	作成日/Date 2019/07/19	5 / 5