

※ゴム足寸法は含んでおりません。  
 ※Rubber feet dimensions are not included.

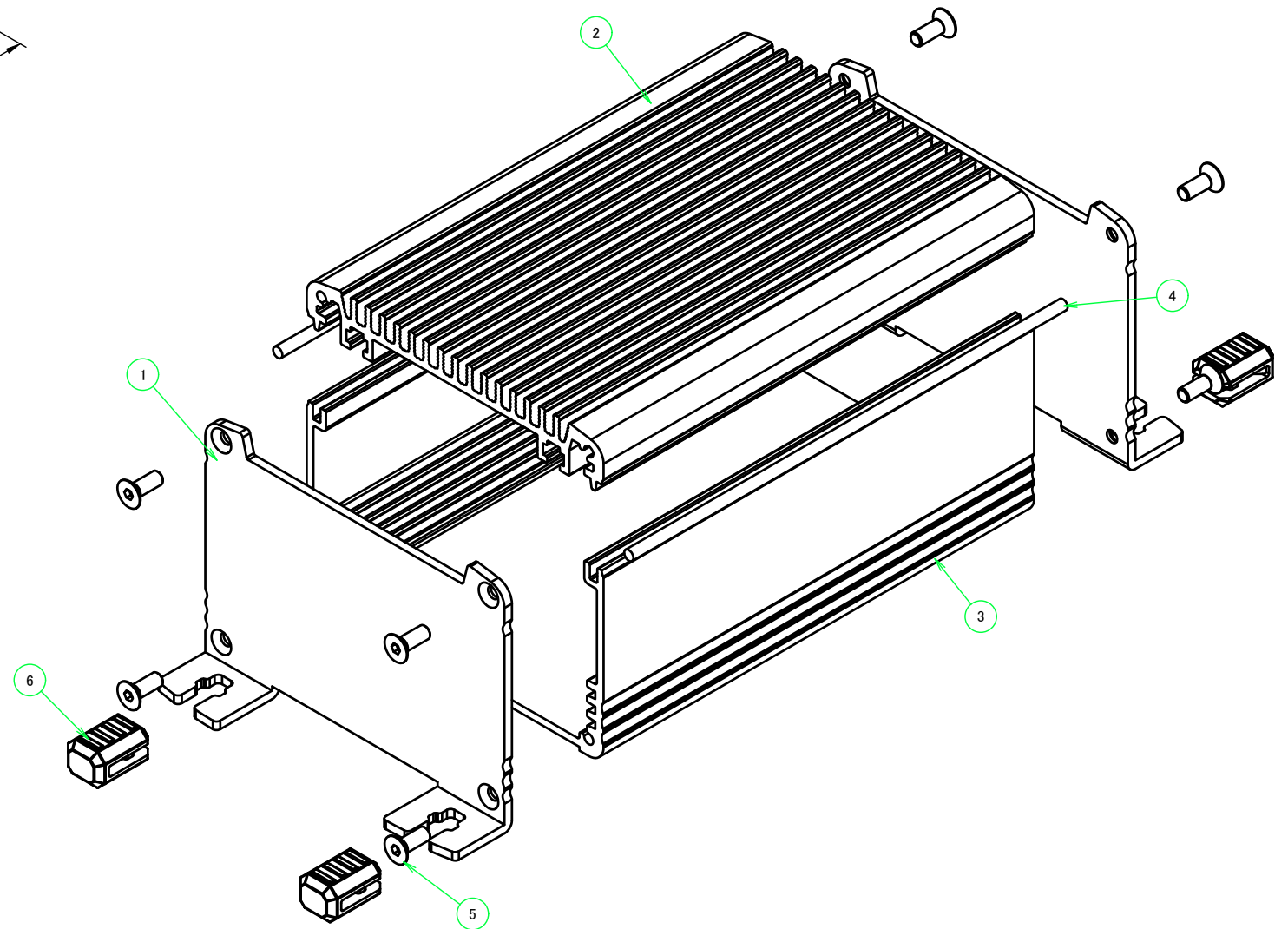

| 構成内容 / Components |   |          |  |   |
|-------------------|---|----------|--|---|
| No.               | 名称 / Part name                                    | 数量 / Pcs | 材質 / Material                                    | 色・表面処理 / Color・Finish   |
| 1                 | フランジパネル<br>Flanged panel                          | 2        | アルミ板 A1050P<br>Aluminium A1050P                  | メタリックシルバー・表面塗装・裏面無処理<br>Metallic silver・Painted ( Unfinished inside ) |
| 2                 | ヒートシンクカバー<br>Heat-sink top cover                  | 1        | アルミ押出材 A6063S-T5<br>Extruded aluminium A6063S-T5 | メタリックシルバー・表面塗装・裏面無処理<br>Metallic silver・Painted ( Unfinished inside ) |
| 3                 | 下カバー<br>Bottom frame                              | 1        | アルミ押出材 A6063S-T5<br>Extruded aluminium A6063S-T5 | メタリックシルバー・表面塗装・裏面無処理<br>Metallic silver・Painted ( Unfinished inside ) |
| 4                 | シールドガスケット<br>Fabric-over-foam gasket              | 2        | 導電性繊維・TPE<br>Conductive fabric・TPE               | メタリックグレー<br>Metallic gray   |
| 5                 | 取付ビス (六角穴付皿 M2.5×8)<br>Screw ( Hexagonal M2.5-8 ) | 8        | ステンレス / Stainless steel                          | 無処理 / Unfinished  |
| 6                 | 差込ゴム足 / Rubber feet                               | 4        | シリコンゴム / Silicone                                | ブラック / Black  |

本図面および付帯する部品図の著作権は株式会社タカチ電機工業に帰属します。 / Copyright (C) TAKACHI ELECTRONICS ENCLOSURE CO., LTD. All Rights Reserved.

|   |            |            |  |                      |
|---|------------|------------|--|----------------------|
| <b>株式会社タカチ電機工業</b><br>TAKACHI ELECTRONICS ENCLOSURE CO., LTD. |            |            | 品名/Title<br>フランジ足付ヒートシンクアルミケースEMCシールドタイプ<br>FLANGED HEAT-SINK ALUMINIUM EMC SHIELD ENCLOSURE | 尺度/Scale<br>1 / 1.25 |
| 承認/Approved   | 検図/Checked | 製図/Created | 型番/Product number<br>EXHFE8-6-12SS   |                      |
| 中根  | 大江         | 岡本         | 作成日/Date<br>2022/12/30   |                      |

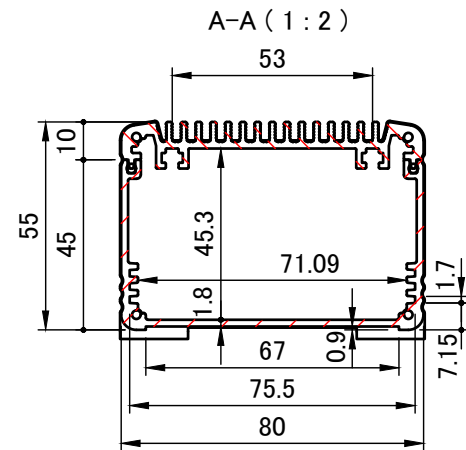
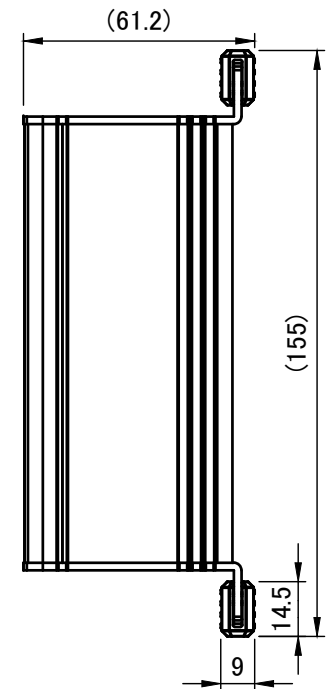
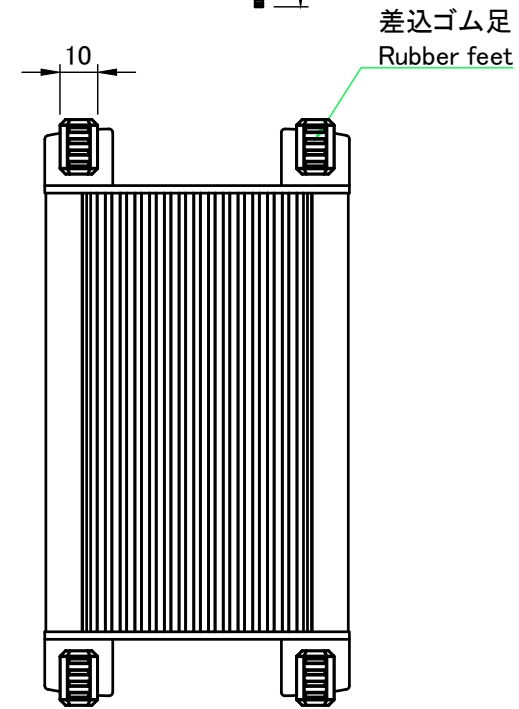
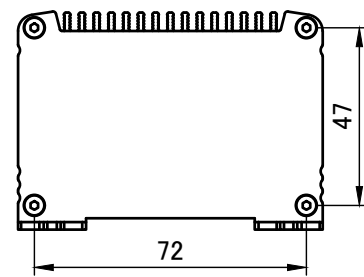
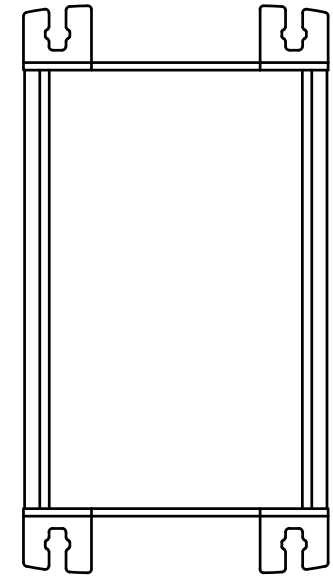
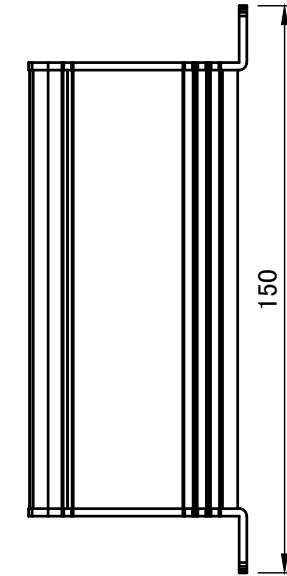
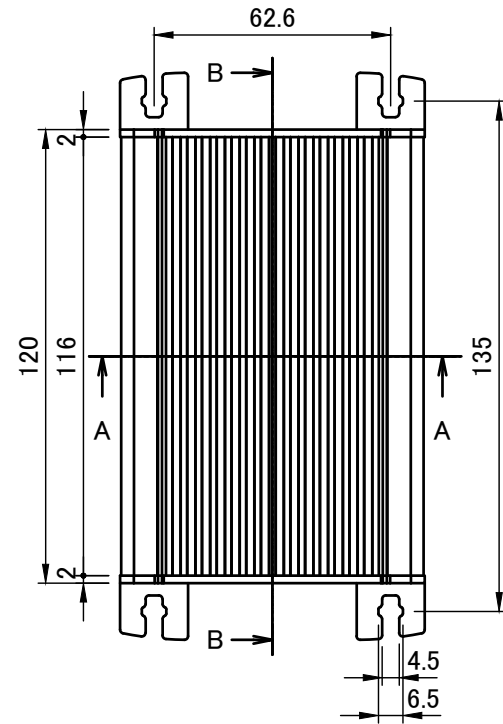
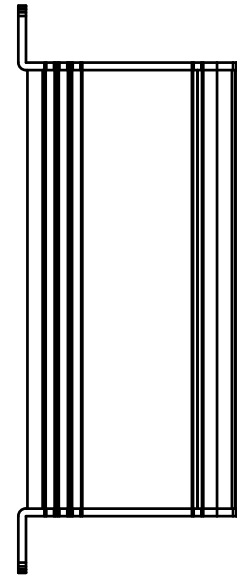
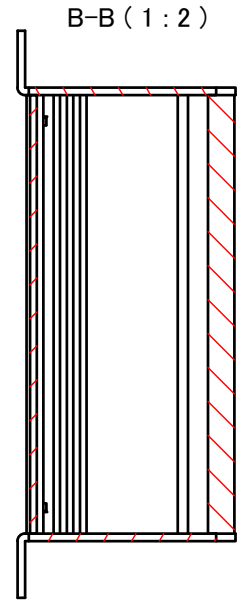
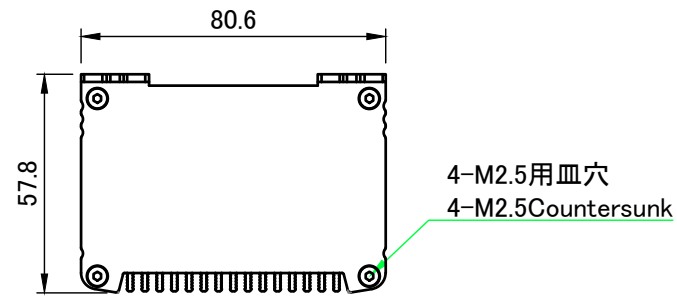

|  |            |            |  |                                      |
|--|------------|------------|--|--------------------------------------|
| 株式会社タカチ電機工業<br>TAKACHI ELECTRONICS ENCLOSURE CO., LTD. |            |            | 品名/Title<br>フランジ足付ヒートシンクアルミケースEMCシールドタイプ<br>FLANGED HEAT-SINK ALUMINIUM EMC SHIELD ENCLOSURE |                                      |
| 承認/Approved  | 検図/Checked | 製図/Created | 型番/Product number<br>EXHFE8-6-12SS   |                                      |
| 中根   | 大江         | 岡本         | 作成日/Date<br>2022/08/05   | 尺度/Scale<br>1:2<br>ページ/Page<br>2 / 5 |

ヒートシンク / Heat-sink top cover

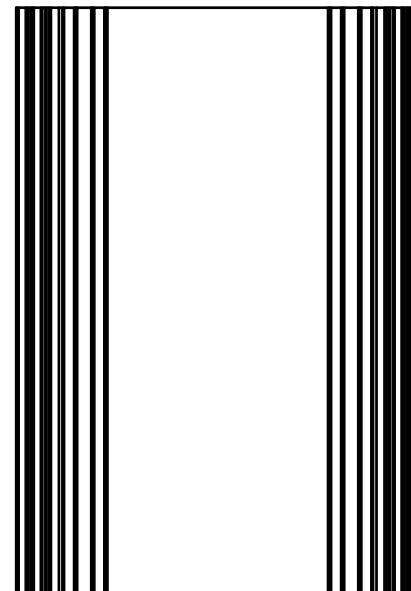
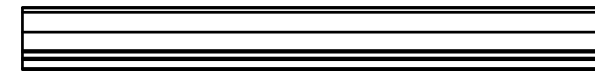
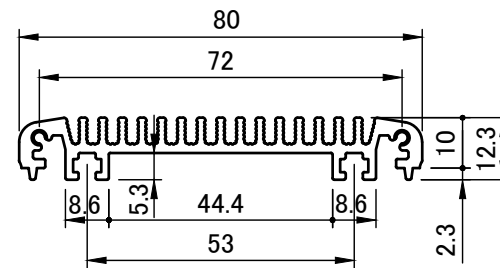
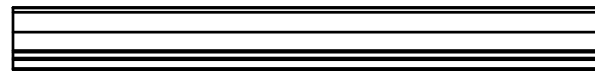
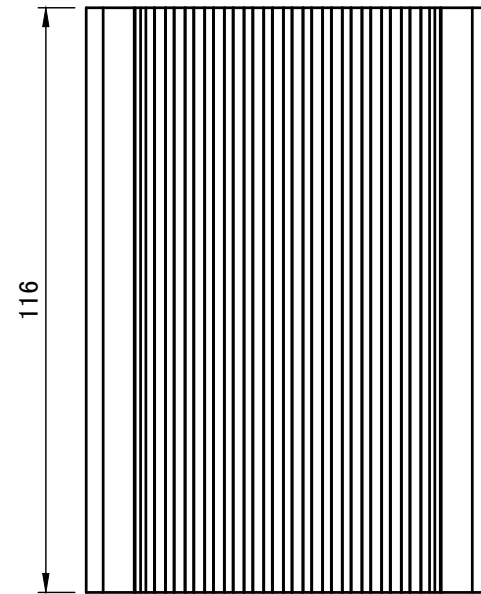

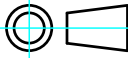
|  |            |  |   |
|--|------------|--|---|
|  株式会社タカチ電機工業<br>TAKACHI ELECTRONICS ENCLOSURE CO., LTD. |            | 品名/Title<br>ヒートシンクカバー<br>HEAT-SINK TOP COVER |  |
| 承認/Approved  | 検図/Checked | 製図/Created                                   |   |
| 中根   | 大江         | 岡本   | 作成日/Date<br>2022/08/05  |
|  |            |  | 尺度/Scale<br>1 : 1.5   |
|  |            |  | ページ/Page<br>3 / 5   |

下カバー / Bottom frame

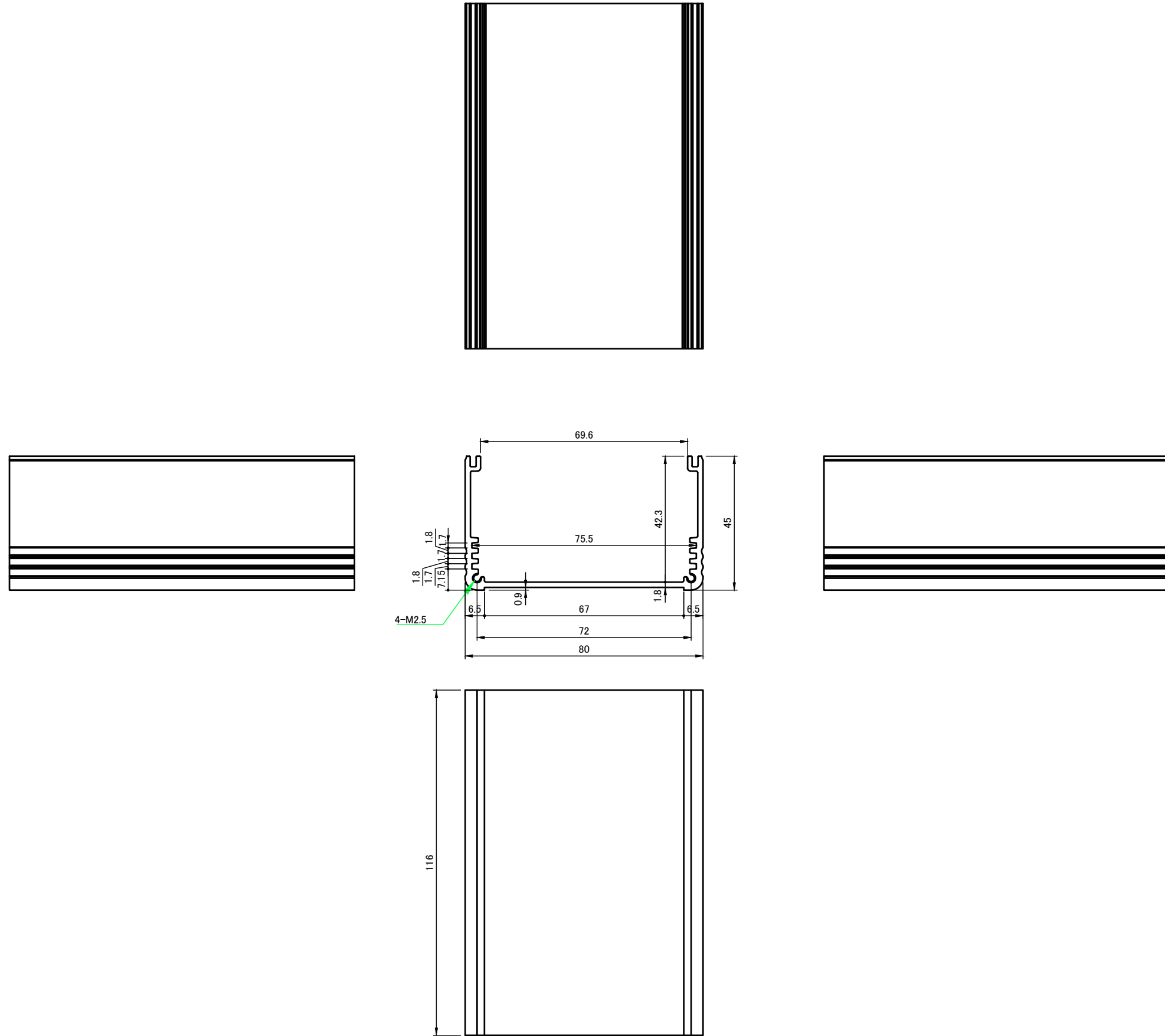

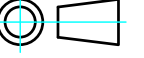
|   |            |            |                                   |   |
|---|------------|------------|-----------------------------------|---|
|  <b>株式会社タカチ電機工業</b><br>TAKACHI ELECTRONICS ENCLOSURE CO., LTD. |            |            | 品名/Title<br>下カバー<br>BOTTOM FRAME  |  |
| 承認/Approved   | 検図/Checked | 製図/Created | 型番/Product number<br>W80-H55-D116 |   |
| 中根  | 大江         | 岡本         | 作成日/Date<br>2022/08/05            | 尺度/Scale<br>1 : 1.5   |
|   |            |            |                                   | ページ/Page<br>4 / 5   |

フランジパネル / Flange Panel

B-B (1:1)

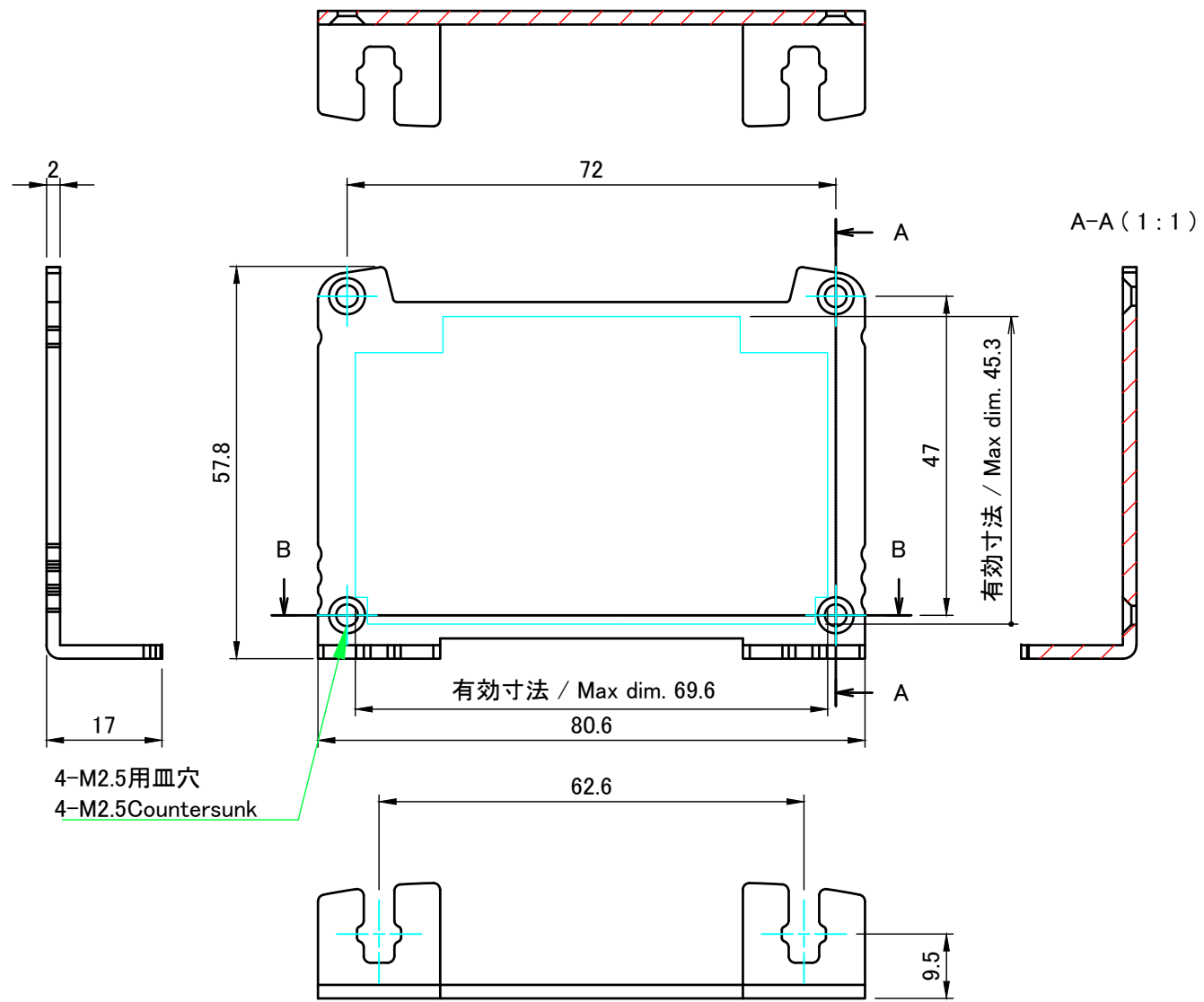

A-A (1:1)

D-D (1:1)

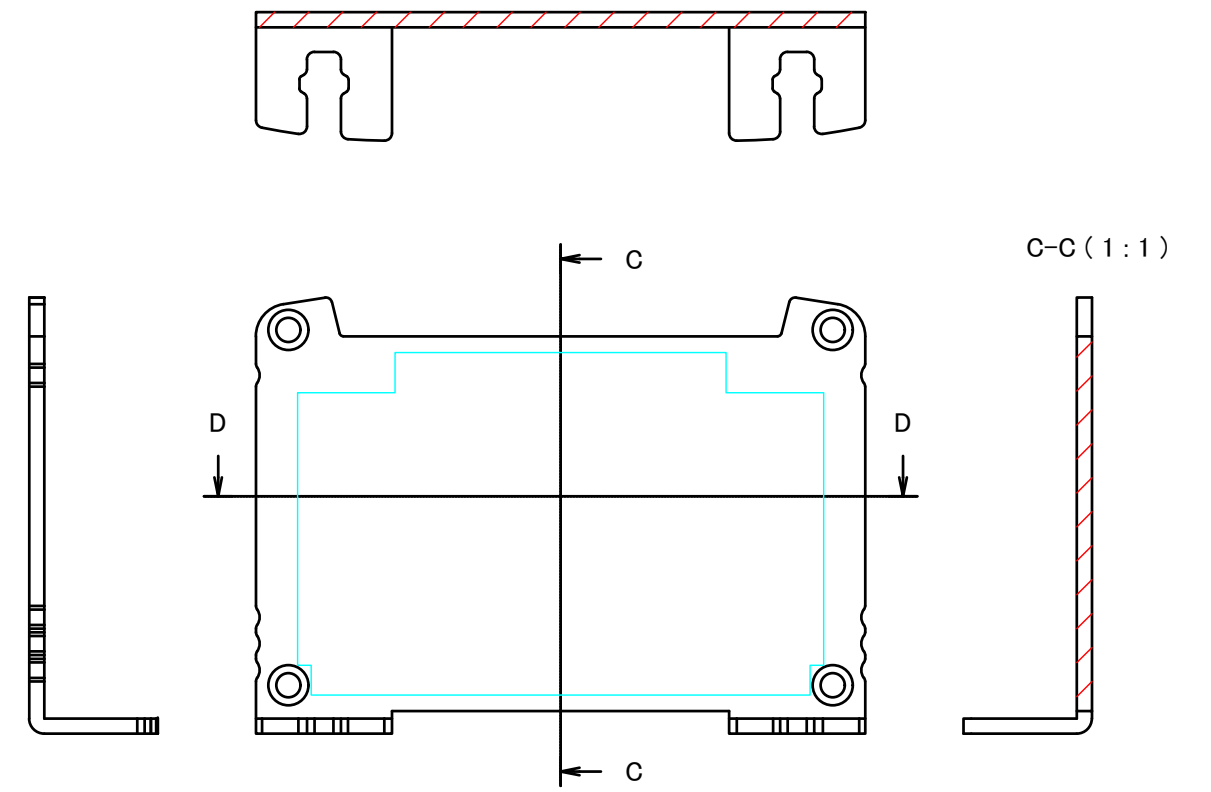

C-C (1:1)

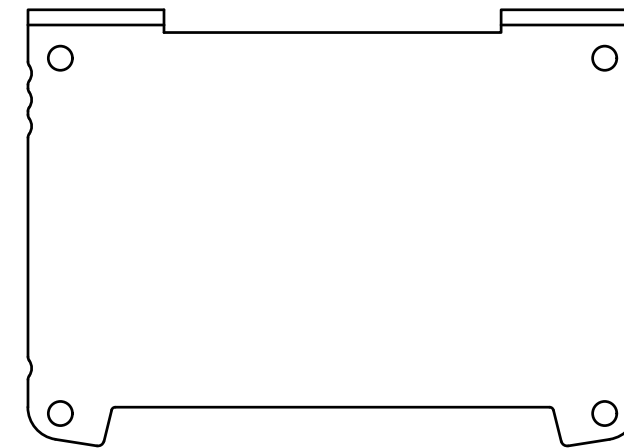
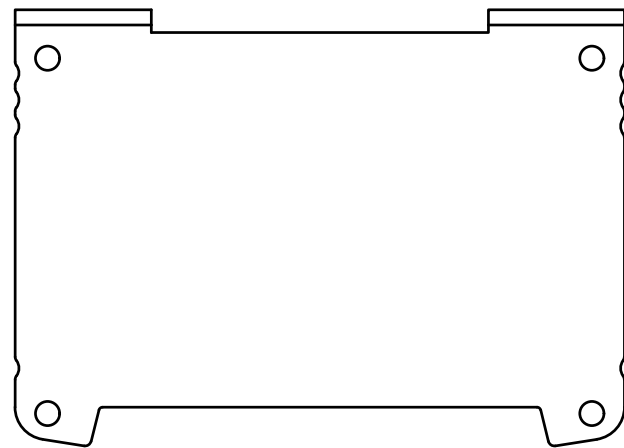

|  |            |            |                                      |                   |
|--|------------|------------|--------------------------------------|-------------------|
| 株式会社タカチ電機工業<br>TAKACHI ELECTRONICS ENCLOSURE CO., LTD. |            |            | 品名/Title<br>フランジパネル<br>FLANGED PANEL | 尺度/Scale<br>1:1   |
| 承認/Approved  | 検図/Checked | 製図/Created | 型番/Product number<br>W80.6-H57.8     |                   |
| 中根   | 野村         | 岡本         | 作成日/Date<br>2023/02/14               | ページ/Page<br>5 / 5 |