

※ゴム足寸法は含んでおりません。
 ※Rubber feet dimensions are not included.

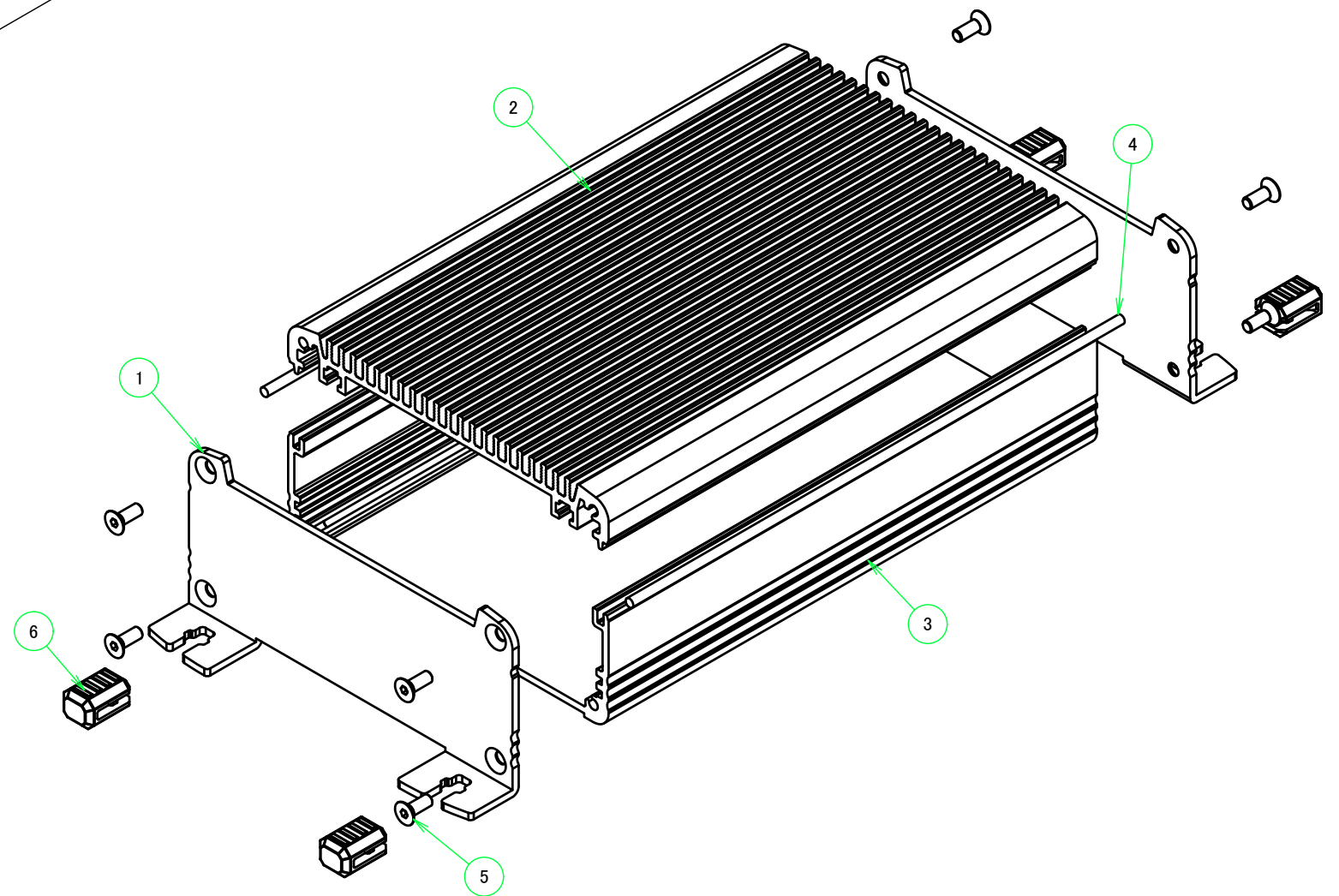

構成内容 / Components				
No.	名称 / Part name	数量 / Pcs	材質 / Material	色・表面処理 / Color・Finish
1	フランジパネル Flanged panel	2	アルミ板 A1050P Aluminium A1050P	メタリックシルバー・表面塗装・裏面無処理 Metallic silver・Painted (Unfinished inside)
2	ヒートシンクカバー Heat-sink top cover	1	アルミ押出材 A6063S-T5 Extruded aluminium A6063S-T5	メタリックシルバー・表面塗装・裏面無処理 Metallic silver・Painted (Unfinished inside)
3	下カバー Bottom frame	1	アルミ押出材 A6063S-T5 Extruded aluminium A6063S-T5	メタリックシルバー・表面塗装・裏面無処理 Metallic silver・Painted (Unfinished inside)
4	シールドガスケット Fabric-over-foam gasket	2	導電性繊維・TPE Conductive fabric・TPE	メタリックグレー Metallic gray
5	取付ビス (六角穴付皿 M3×8) Screw (Hexagonal M3-8)	8	ステンレス / Stainless steel	無処理 / Unfinished
6	差込ゴム足 / Rubber feet	4	シリコンゴム / Silicone	ブラック / Black

本図面および付帯する部品図の著作権は株式会社タカチ電機工業に帰属します。 / Copyright (C) TAKACHI ELECTRONICS ENCLOSURE CO., LTD. All Rights Reserved.

株式会社タカチ電機工業 TAKACHI ELECTRONICS ENCLOSURE CO., LTD.			品名/Title フランジ足付ヒートシンクアルミケースEMCシールドタイプ FLANGED HEAT-SINK ALUMINIUM EMC SHIELD ENCLOSURE	
承認/Approved	検図/Checked	製図/Created	型番/Product number	尺度/Scale
中根	大江	岡本	EXHFE11-5-16SS	1 / 1.5
			作成日/Date	ページ/Page
			2022/12/30	1 / 5

B-B (1:2.5)

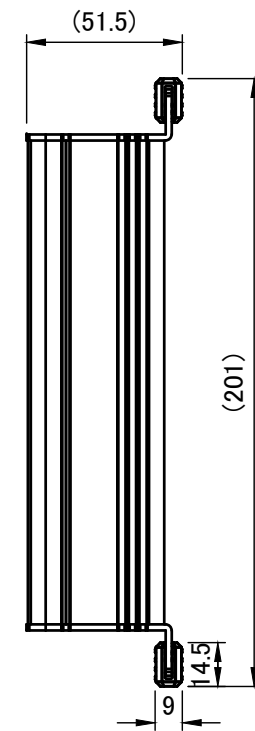
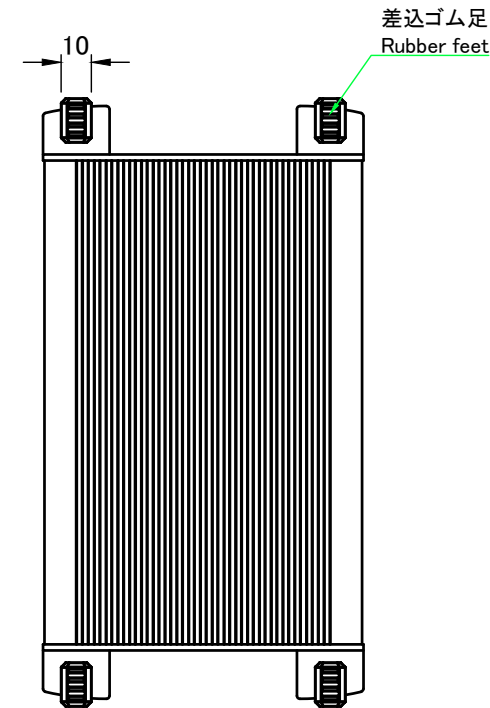
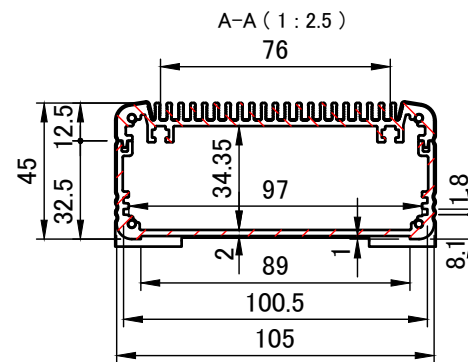
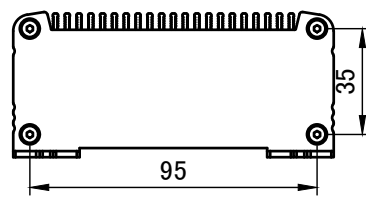
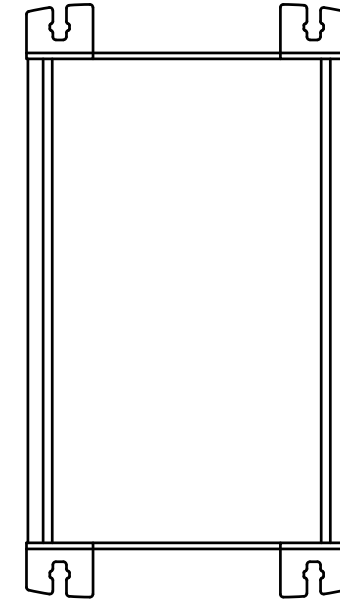
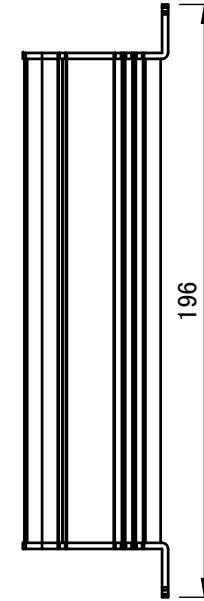
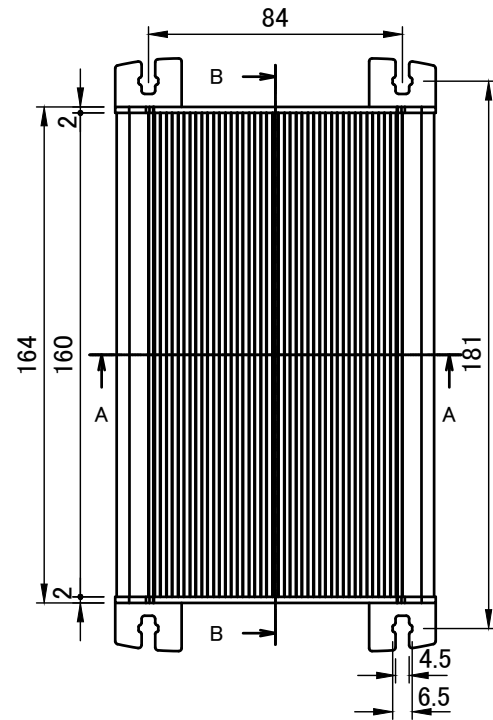
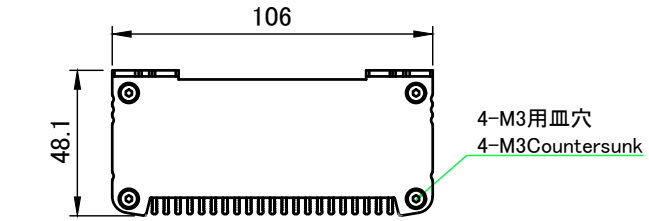
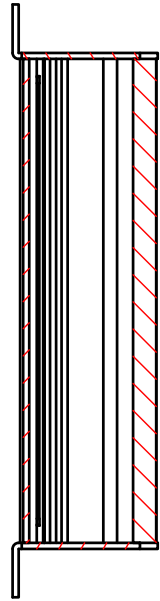

株式会社タカチ電機工業 <small>TAKACHI ELECTRONICS ENCLOSURE CO., LTD.</small>			品名/Title フランジ足付ヒートシンクアルミケースEMCシールドタイプ FLANGED HEAT-SINK ALUMINIUM EMC SHIELD ENCLOSURE	尺度/Scale 1:2.5
承認/Approved	検図/Checked	製図/Created	型番/Product number EXHFE11-5-16SS	
中根	大江	岡本	作成日/Date 2022/08/05	ページ/Page 2 / 5

ヒートシンク / Heat-sink top cover

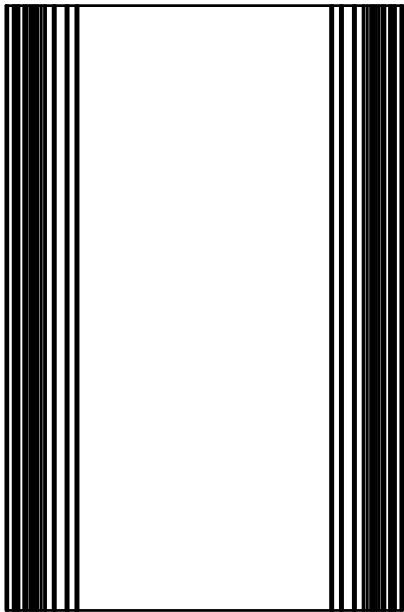
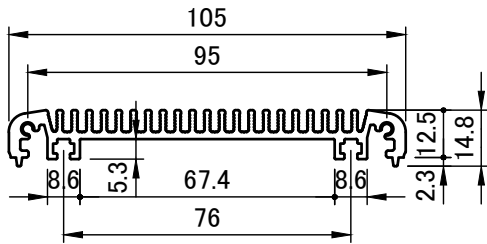
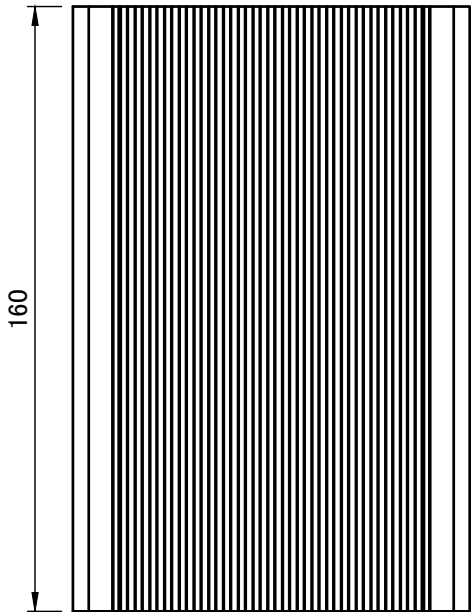

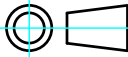
 株式会社タカチ電機工業 TAKACHI ELECTRONICS ENCLOSURE CO., LTD.		品名/Title ヒートシンクカバー HEAT-SINK TOP COVER	
承認/Approved	検図/Checked	製図/Created	
中根	大江	岡本	作成日/Date 2022/08/05
			尺度/Scale 1 : 2
			ページ/Page 3 / 5

下カバー / Bottom frame

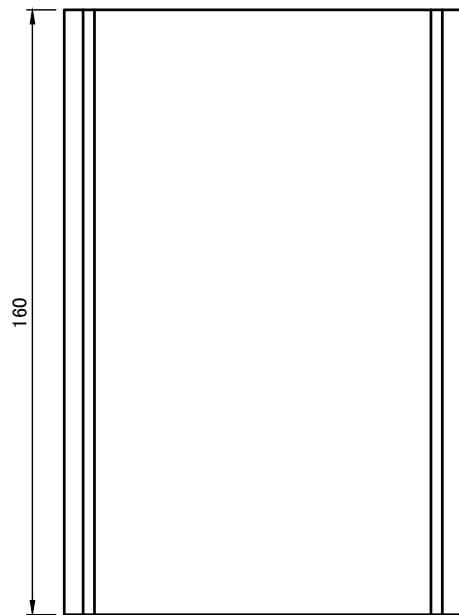
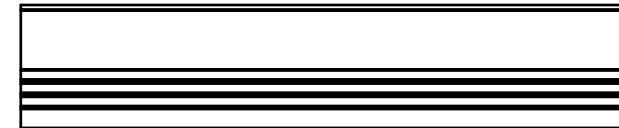
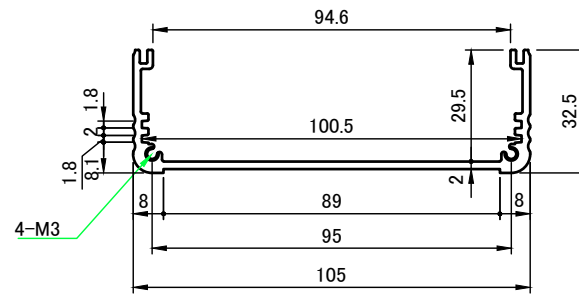
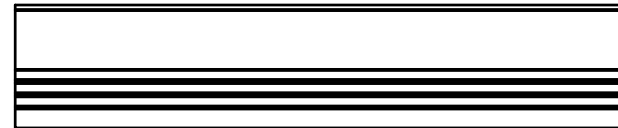
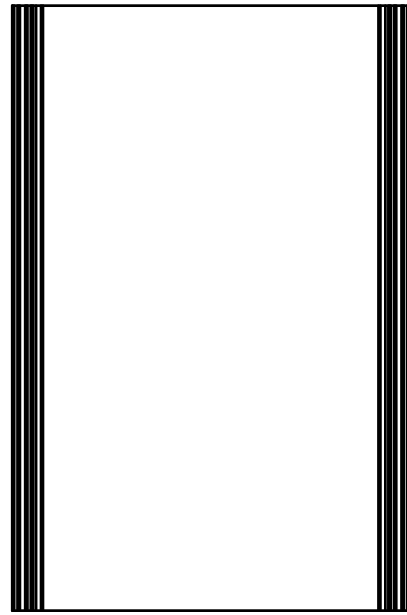

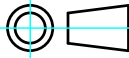
 株式会社タカチ電機工業 TAKACHI ELECTRONICS ENCLOSURE CO., LTD.			品名/Title 下カバー BOTTOM FRAME	
承認/Approved	検図/Checked	製図/Created	型番/Product number W105-H45-D160	尺度/Scale 1 : 2
中根	大江	岡本	作成日/Date 2022/08/05	ページ/Page 4 / 5

フランジパネル / Flange Panel

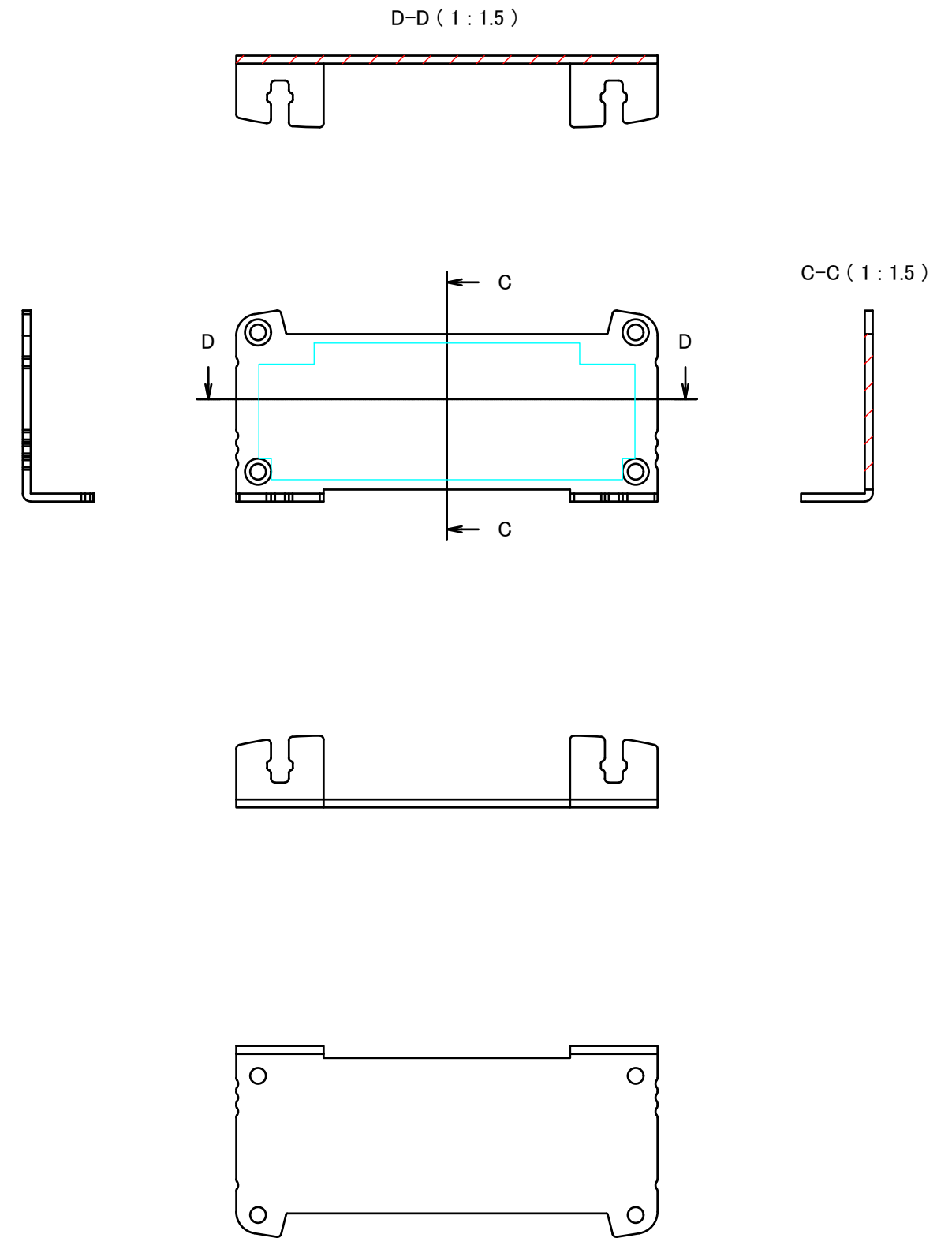
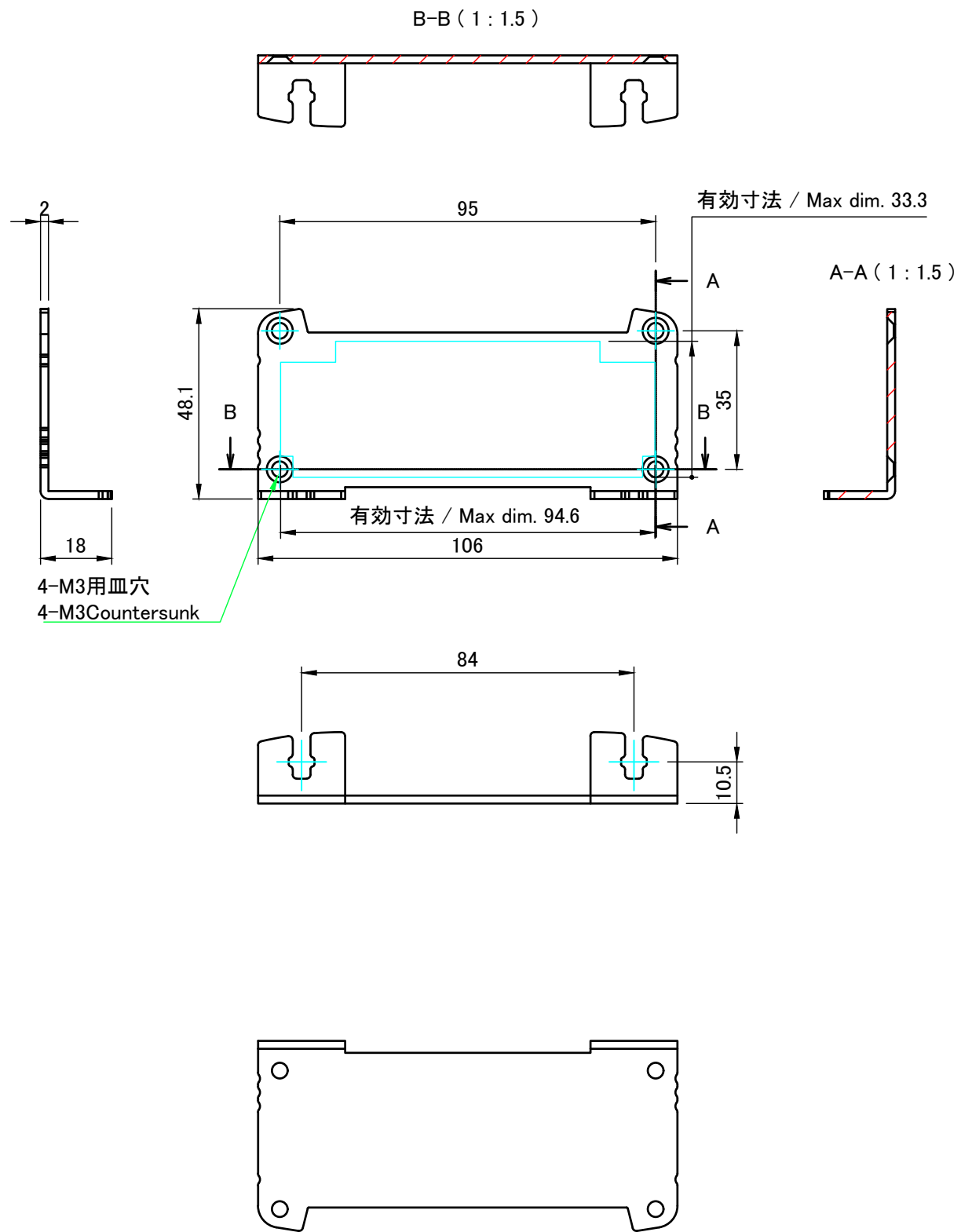

株式会社タカチ電機工業 <small>TAKACHI ELECTRONICS ENCLOSURE CO., LTD.</small>			品名/Title フランジパネル FLANGED PANEL	尺度/Scale 1 : 1.5
承認/Approved	検図/Checked	製図/Created	型番/Product number W106-H48.1	
中根	野村	岡本	作成日/Date 2023/02/14	ページ/Page 5 / 5