

構成内容 / Components				
No.	名称 / Part name	数量 / Pcs	材質 / Material	色・表面処理 / Color・Finish
1	パネル / Panel	2	アルミ板 / Aluminium A1050P	シルバーアルマイト,ブラックアルマイト / Silver,Black・Anodized
2	ヒートシンクカバー / Heat-sink top cover	1	アルミ押出材 / Extruded aluminium A6063S-T5	シルバーアルマイト,ブラックアルマイト / Silver,Black・Anodized
3	下カバー / Bottom frame	1	アルミ押出材 / Extruded aluminium A6063S-T5	シルバーアルマイト,ブラックアルマイト / Silver,Black・Anodized
4	取付ビス(M5×10 皿六角穴付) / Screw	8	ステンレス / Stainless steel	無処理 / Unfinished
5	ゴム足 / Rubber feet	4	ポリウレタン / Polyurethane	ブラック / Black

※ゴム足は任意の場所に貼り付けできます。

※Adhesive rubber feet in cluded.

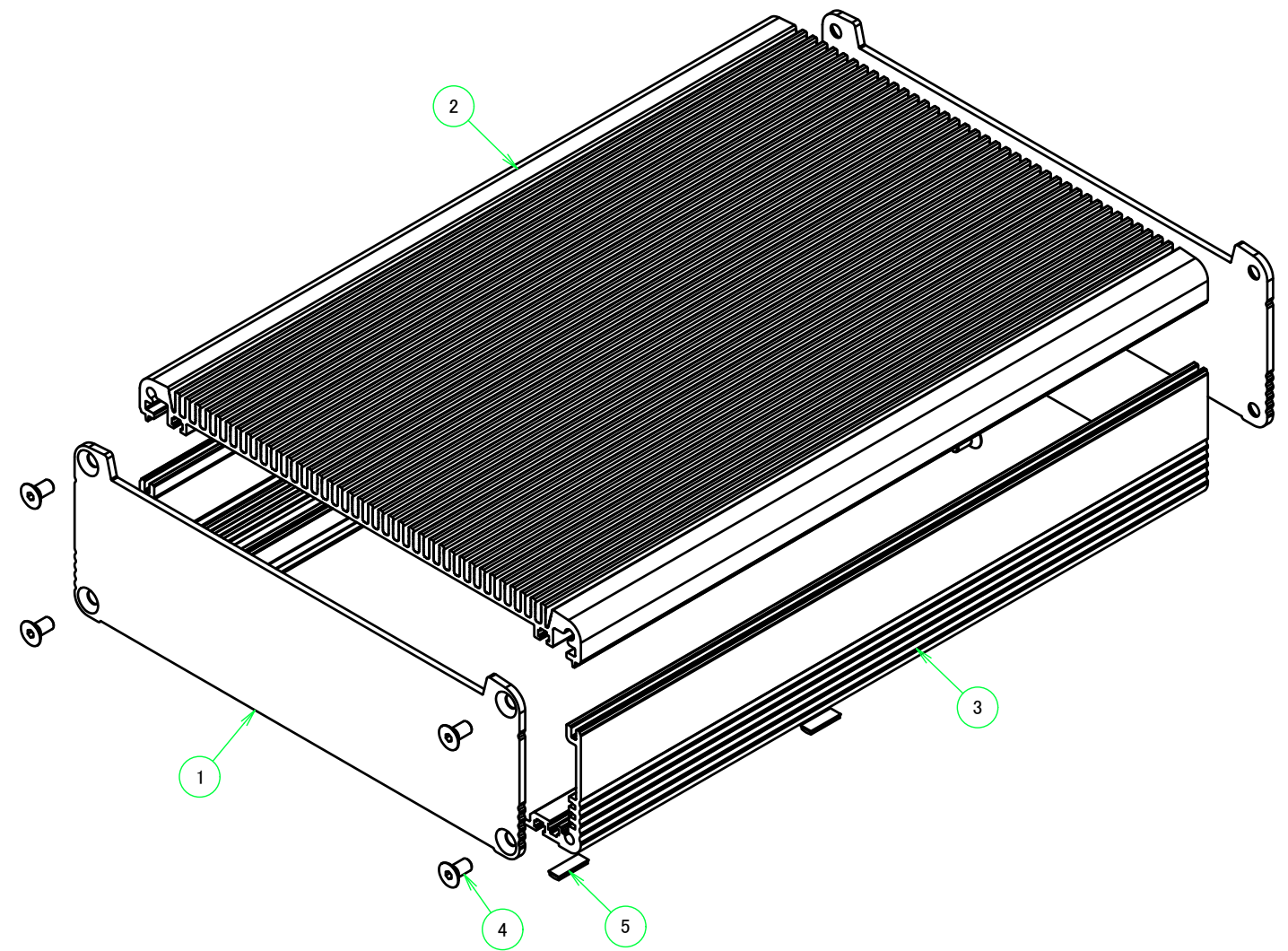
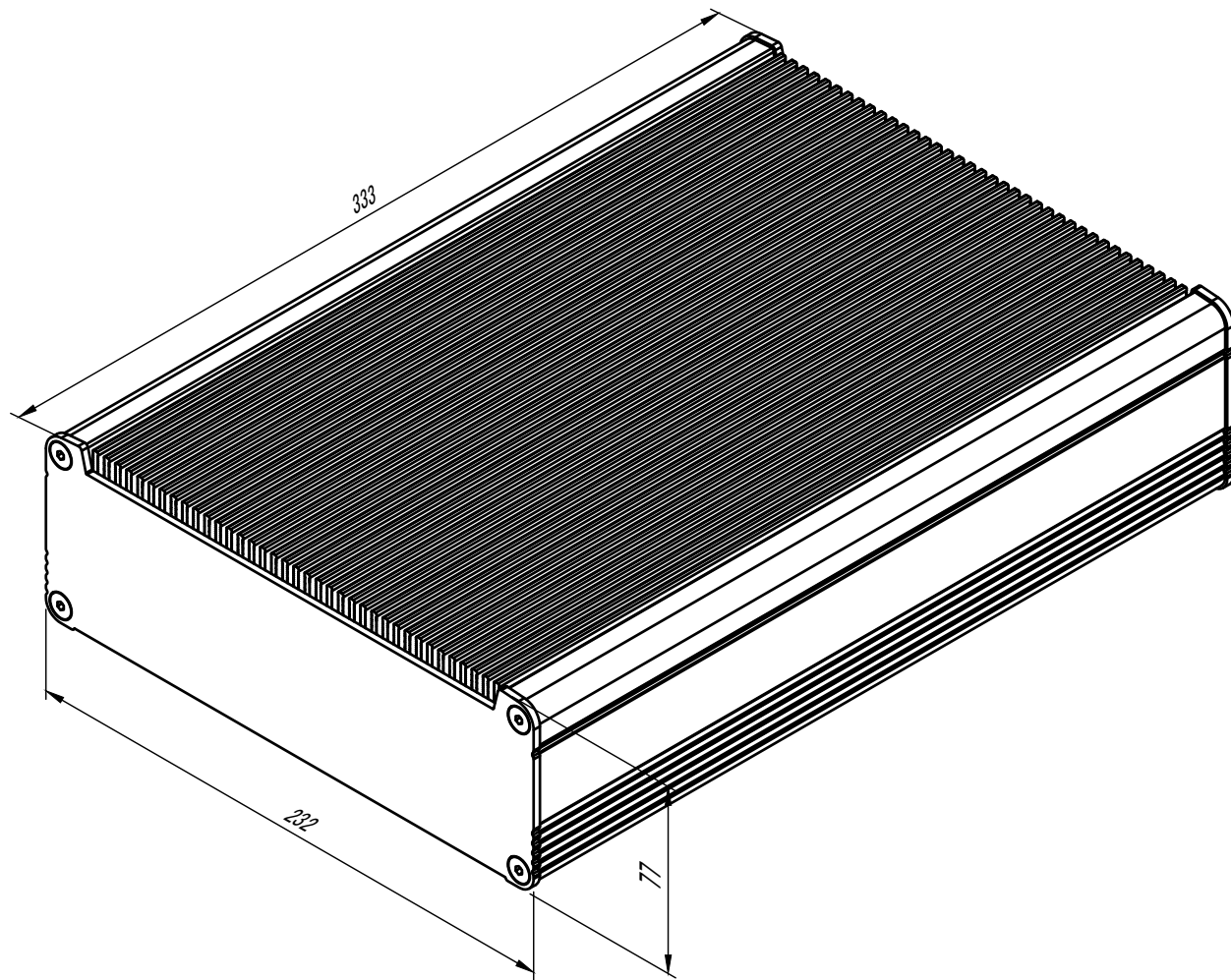

色仕様(型番末尾口)/Color type		
記号/Code	上下カバー/Cover	パネル/Panel
SS	シルバー/Silver	シルバー/Silver
SB	シルバー/Silver	ブラック/Black
BS	ブラック/Black	シルバー/Silver
BB	ブラック/Black	ブラック/Black

株式会社タカチ電機工業 TAKACHI ELECTRONICS ENCLOSURE CO., LTD.			品名/Title ヒートシンクアルミケース HEAT-SINK ALUMINIUM ENCLOSURE	尺度/Scale 1 : 2.5
承認/Approved	検図/Checked	製図/Created	型番/Product number EXH23-8-33□□	
中根	大江	岡本	作成日/Date 2019/02/08	1 / 5

ゴム足
Rubber feet

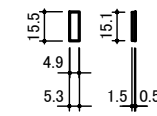

4-M5皿ビス
4-M5Countersunk

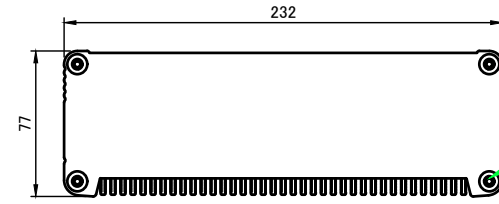

B-B (1:4)

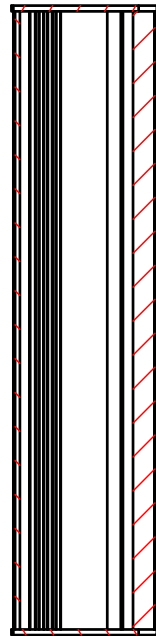

C D

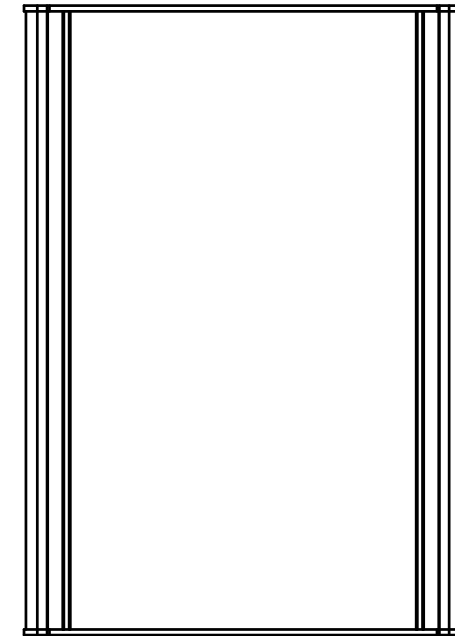
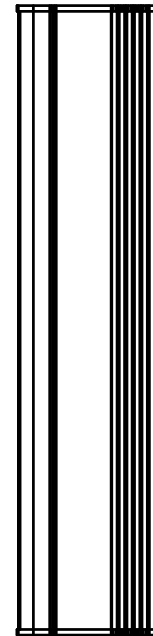
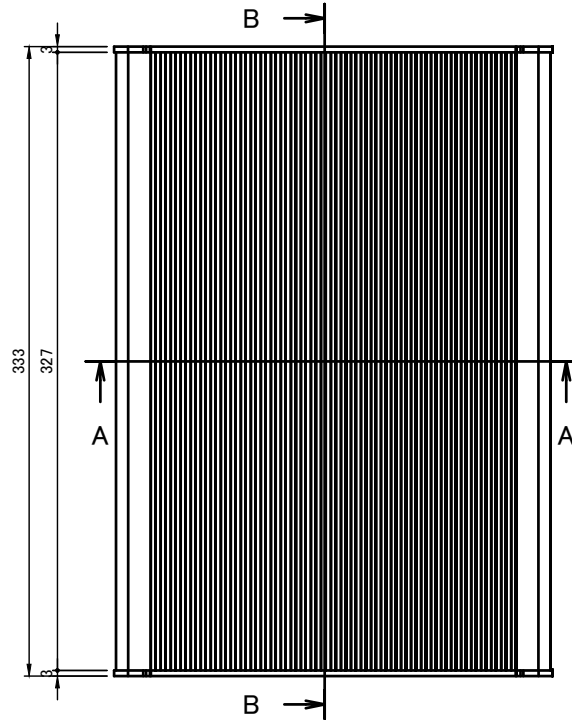
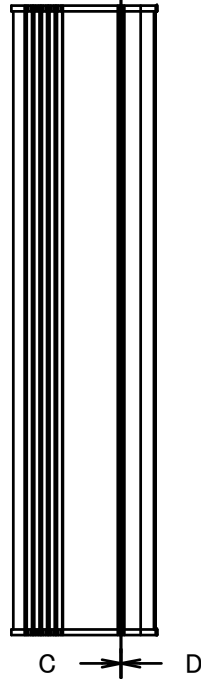

C-C (1:4)

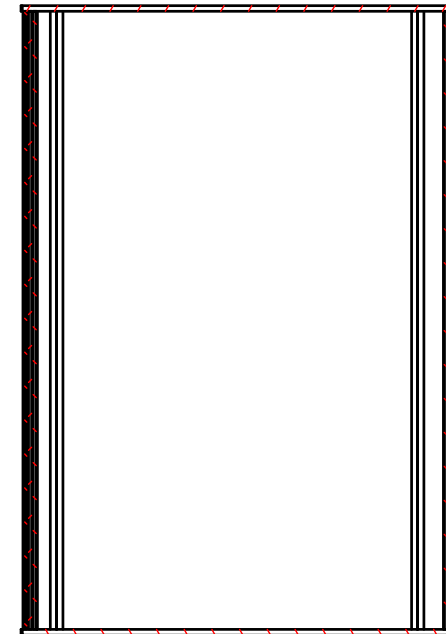

D-D (1:4)

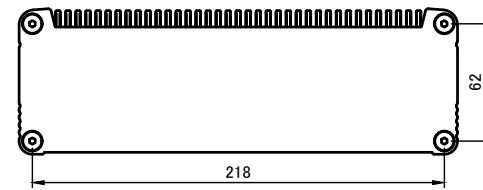
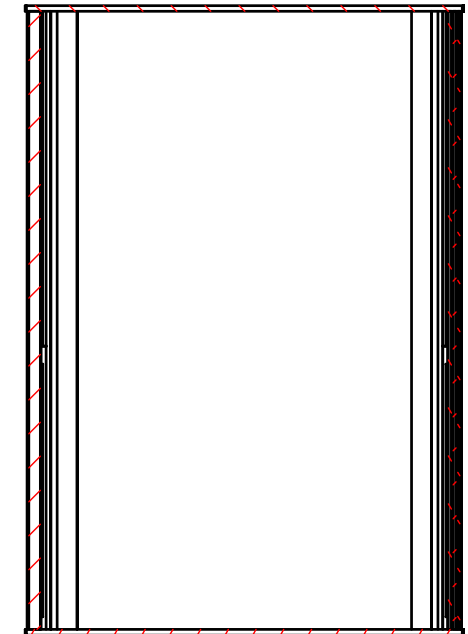

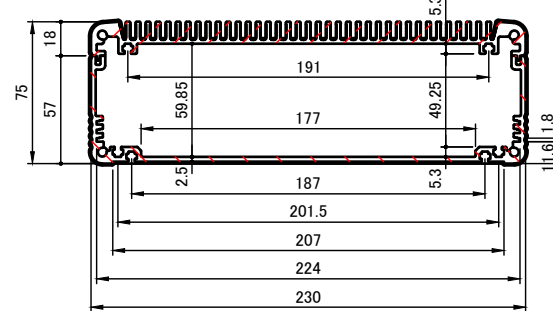

A-A (1:4)



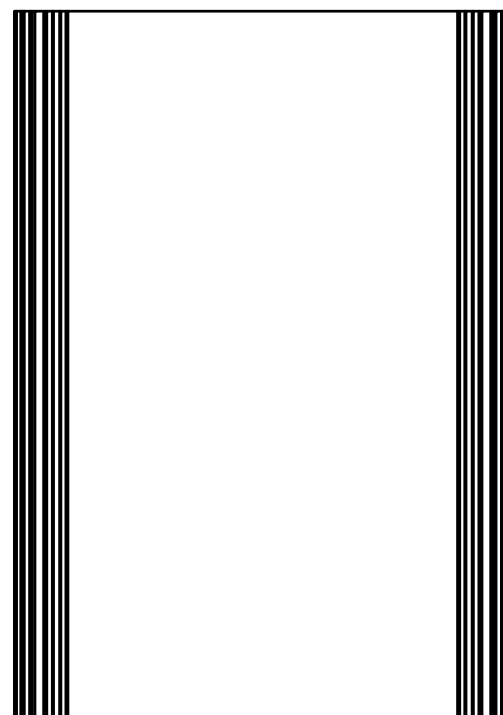
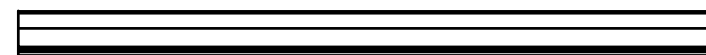
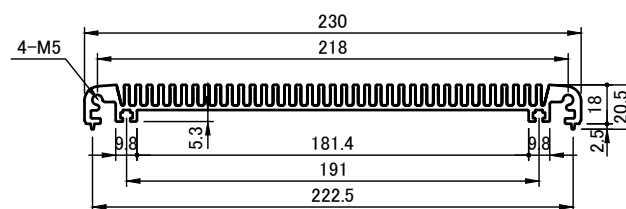
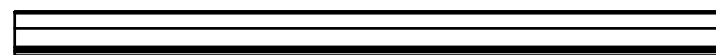
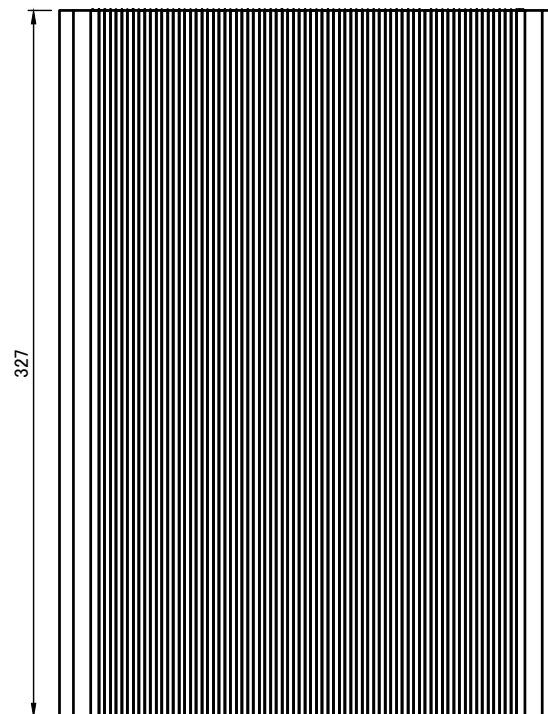

株式会社タカチ電機工業 TAKACHI ELECTRONICS ENCLOSURE CO., LTD.			品名/Title ヒートシンクアルミケース HEAT-SINK ALUMINIUM ENCLOSURE	尺度/Scale 1:4
承認/Approved	検図/Checked	製図/Created	型番/Product number EXH23-8-33□□	
中根	大江	岡本	作成日/Date 2019/02/13	2 / 5

ヒートシンク / Heat-sink

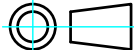

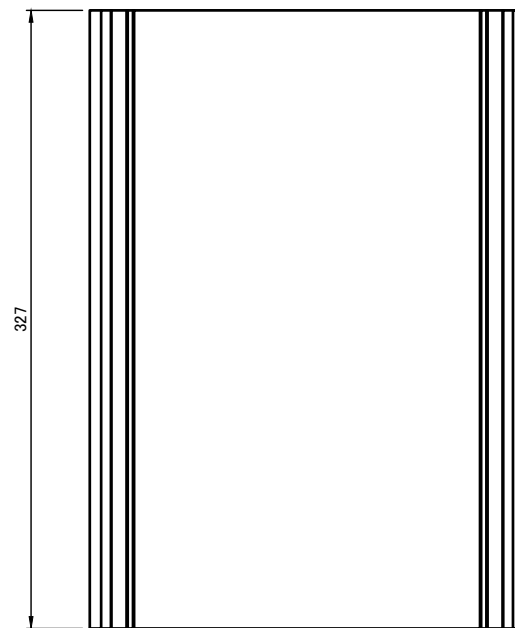
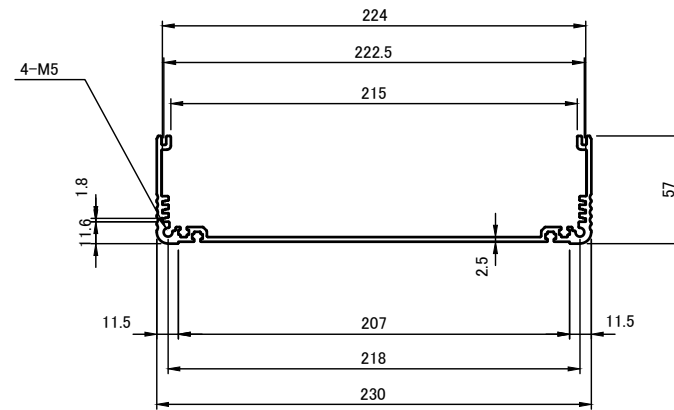
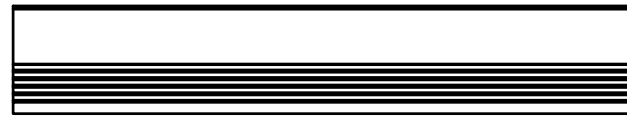
 株式会社タカチ電機工業 TAKACHI ELECTRONICS ENCLOSURE CO., LTD.			品名/Title ヒートシンクアルミケース HEAT-SINK ALUMINIUM ENCLOSURE	 尺度/Scale 1 : 3.5
承認/Approved	検図/Checked	製図/Created	型番/Product number EXH23-〇-33	
中根	大江	岡本	作成日/Date 2019/02/12	3 / 5

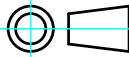

 株式会社タカチ電機工業 TAKACHI ELECTRONICS ENCLOSURE CO., LTD.			品名/Title 下カバー BOTTOM COVER	 尺度/Scale 1:4
承認/Approved 中根	検図/Checked 岡本	製図/Created 大江	型番/Product number W230-H75-D327	
			作成日/Date 2019/01/15	4 / 5

パネル / End panel

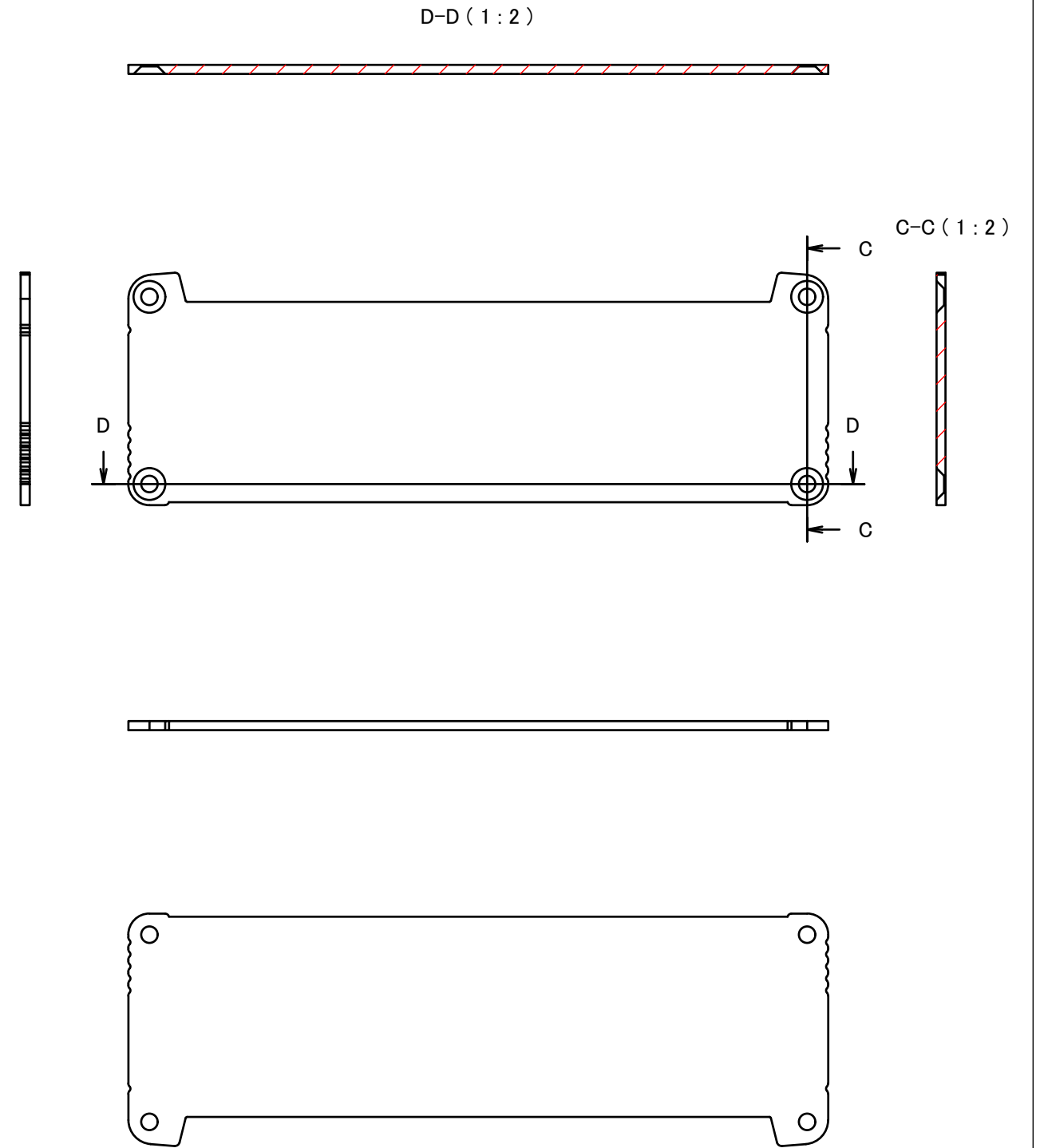
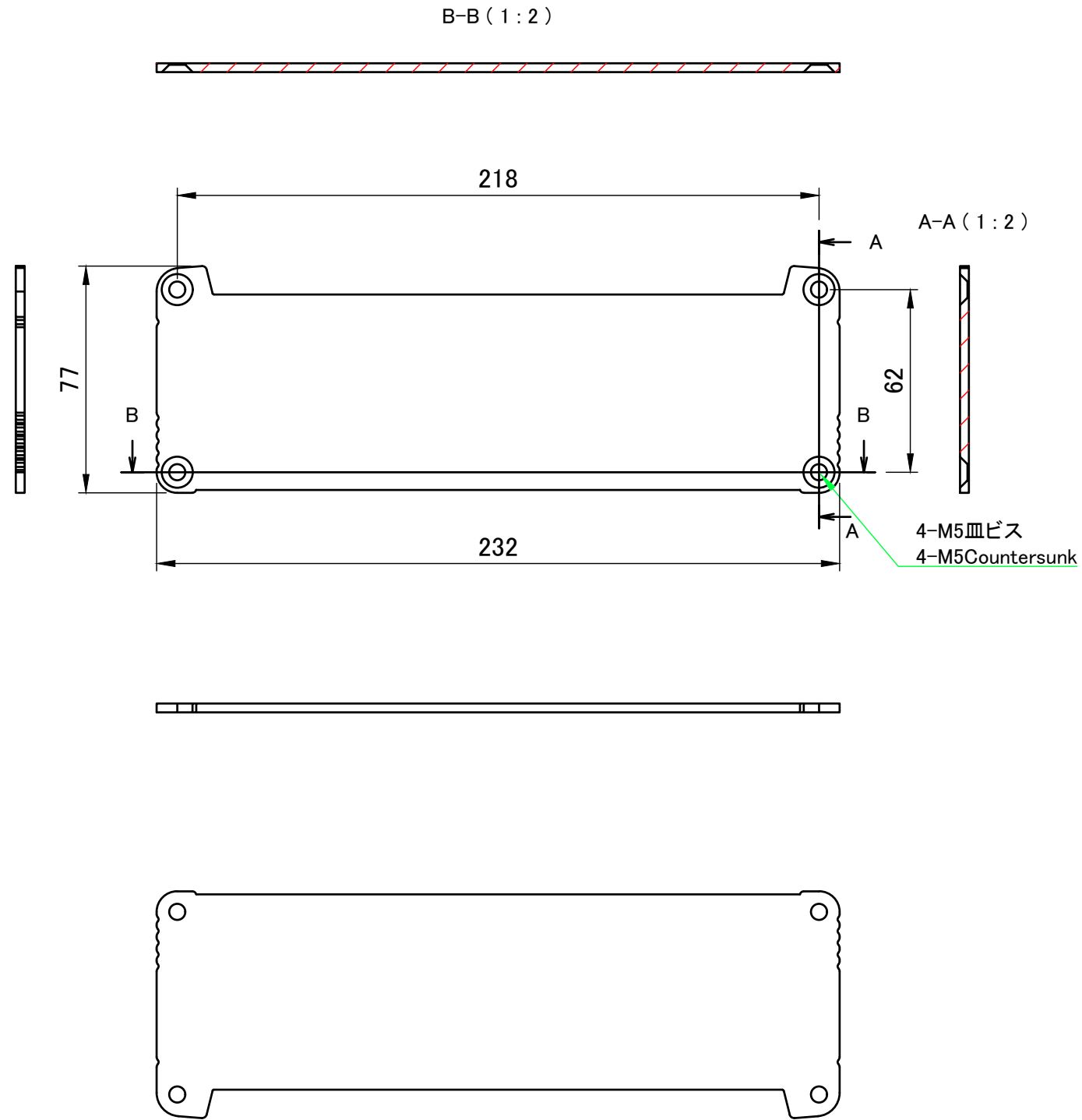

株式会社タカチ電機工業 <small>TAKACHI ELECTRONICS ENCLOSURE CO., LTD.</small>			品名/Title ヒートシンクアルミケース HEAT-SINK ALUMINIUM ENCLOSURE	尺度/Scale 1:2
承認/Approved	検図/Checked	製図/Created	型番/Product number EXH23-8-〇	
中根	大江	岡本	作成日/Date 2019/02/12	5 / 5