

構成内容 / Components				
No.	名称 / Part name	数量 / Pcs	材質 / Material	色・表面処理 / Color・Finish
1	パネル / Panel	2	アルミ板 / Aluminium A1050P	シルバーアルマイト,ブラックアルマイト / Silver,black・Anodized
2	ヒートシカパー / Heat-sink top cover	1	アルミ押出材 / Extruded aluminium A6063S-T5	シルバーアルマイト,ブラックアルマイト / Silver,black・Anodized
3	下カバー / Bottom frame	1	アルミ押出材 / Extruded aluminium A6063S-T5	シルバーアルマイト,ブラックアルマイト / Silver,black・Anodized
4	取付ビス(M3×8皿六角穴付) / Screw	8	ステンレス / Stainless steel	無処理 / Unfinished
5	ゴム足 / Rubber feet	4	ポリウレタン / Polyurethane	ブラック / Black

※ゴム足は任意の場所に貼り付けできます。
 ※Adhesive rubber feet in cluded.

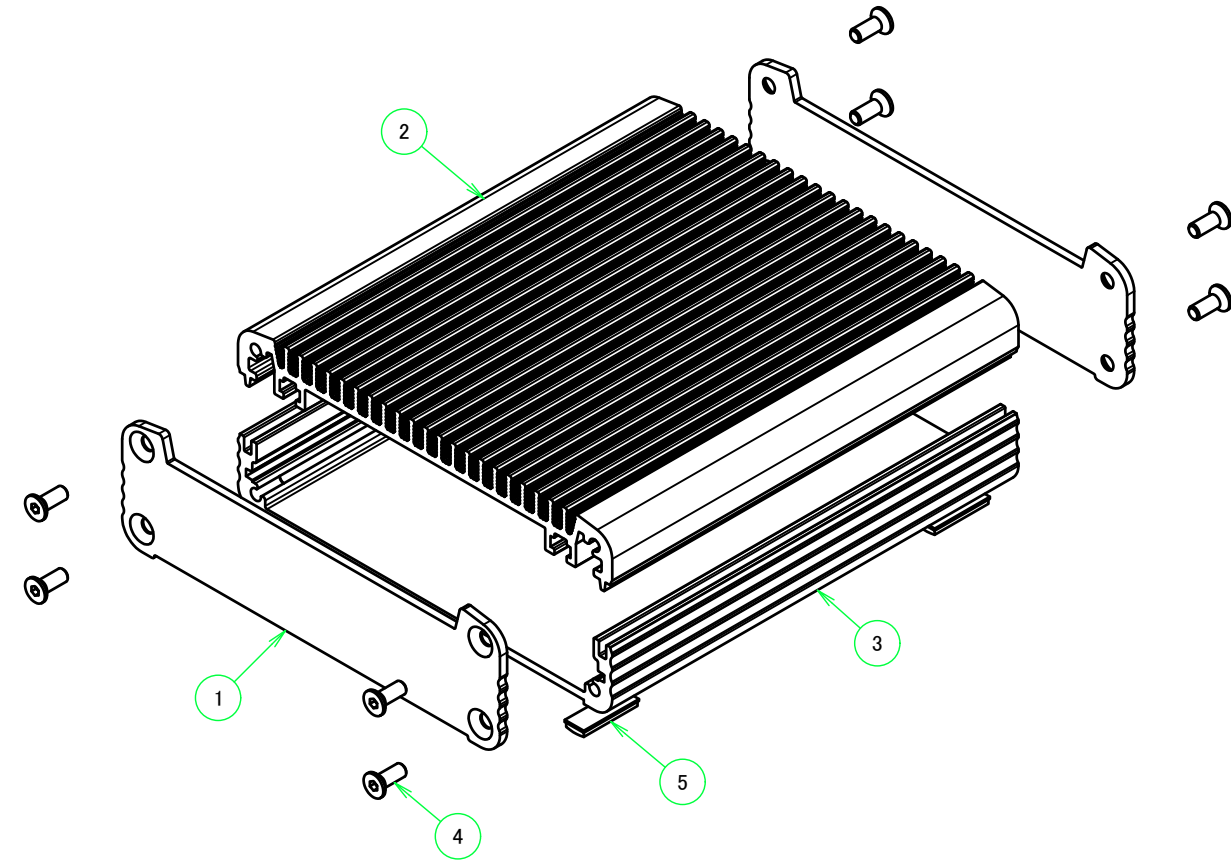
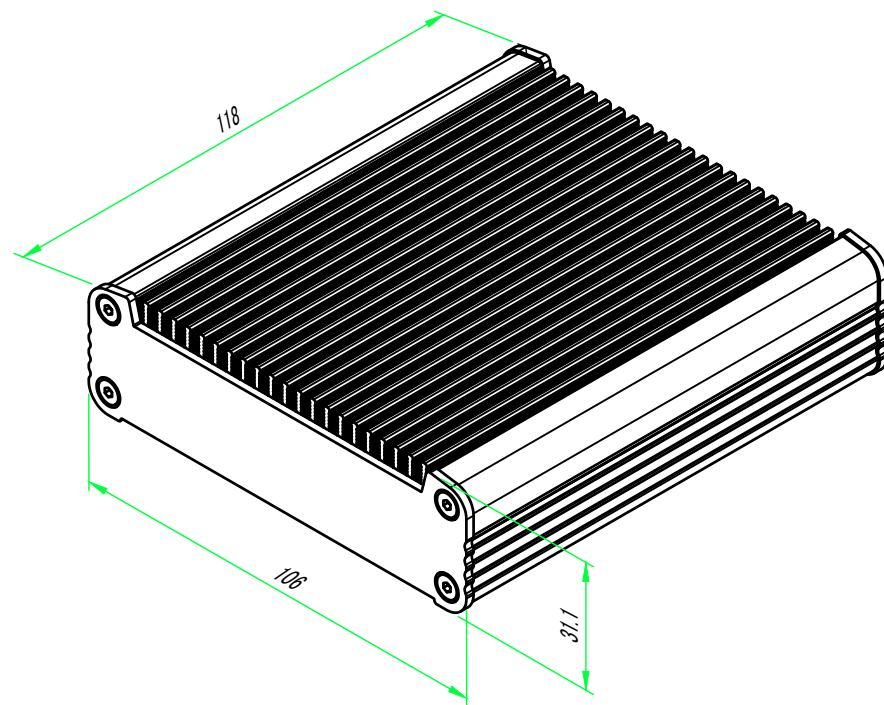

色仕様(型番末尾口)/Color type		
記号/Code	上下カバー/Cover	パネル/Panel
SS	シルバー/Silver	シルバー/Silver
SB	シルバー/Silver	ブラック/Black
BS	ブラック/Black	シルバー/Silver
BB	ブラック/Black	ブラック/Black

株式会社タカチ電機工業 <small>TAKACHI ELECTRONICS ENCLOSURE CO., LTD.</small>			品名/Title ヒートシンクアルミケース HEAT-SINK ALUMINIUM ENCLOSURE	
承認/Approved	検図/Checked 大江	製図/Created 岡本	型番/Product number EXH11-3-12□□	尺度/Scale 1 : 1.5
			作成日/Date 2017/03/31	1 / 5

ゴム足
Rubber feet

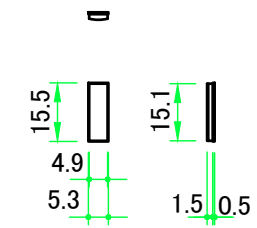

4-M3皿ビス
4-M3 Countersunk

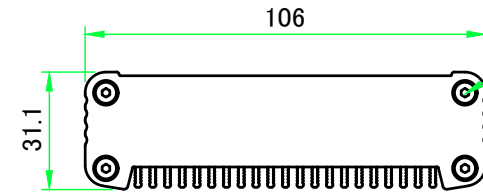

B-B (1:2)

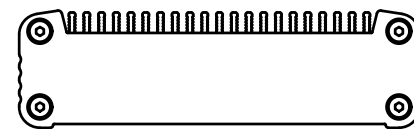
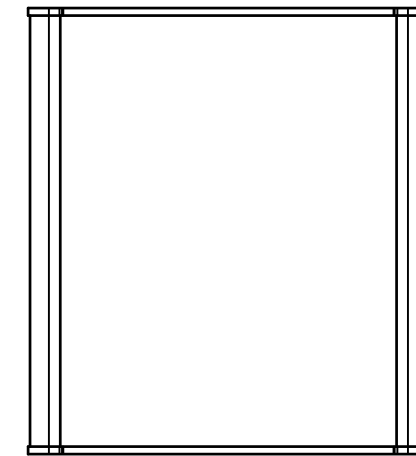
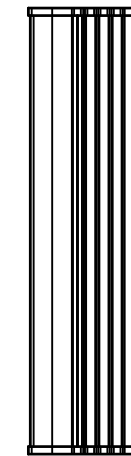
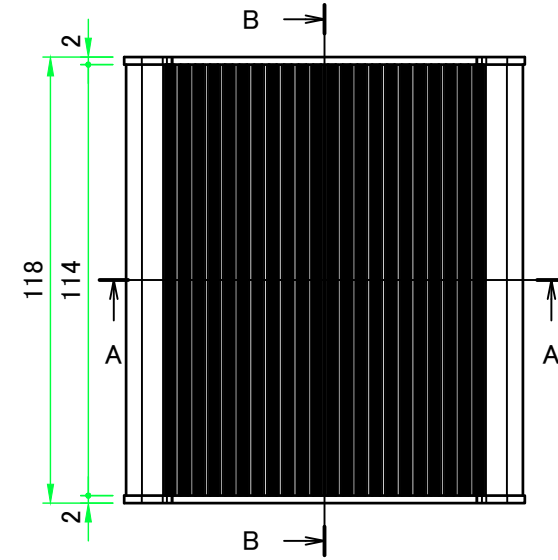
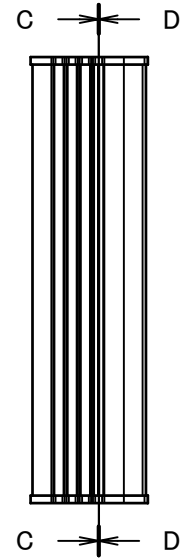
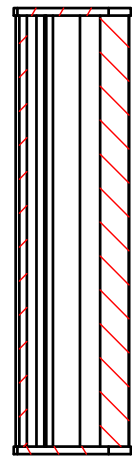

C-C (1:2)

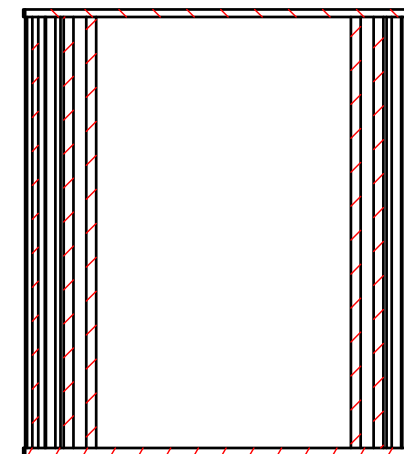

D-D (1:2)

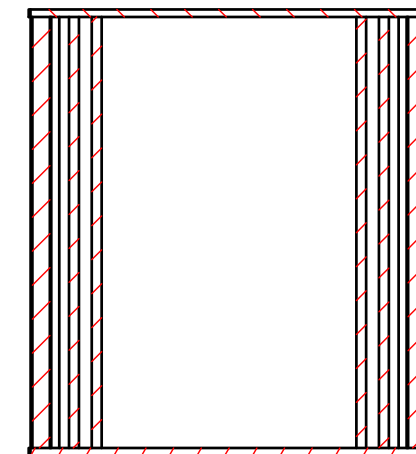

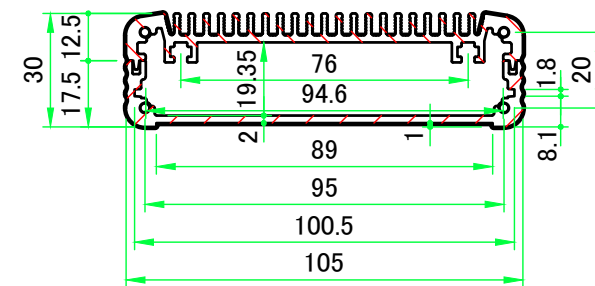

A-A (1:2)



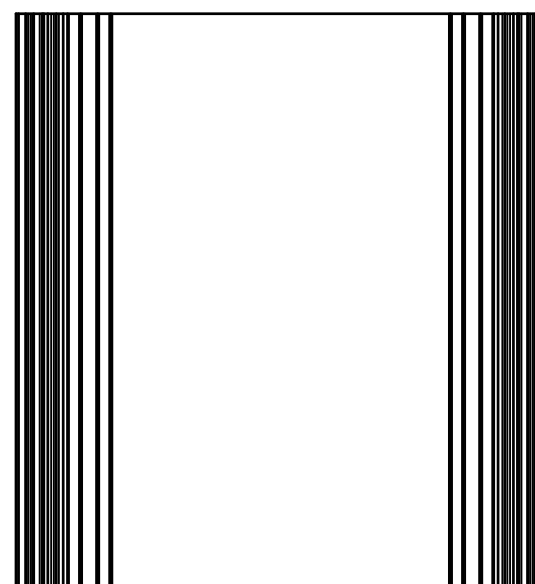
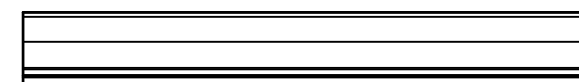
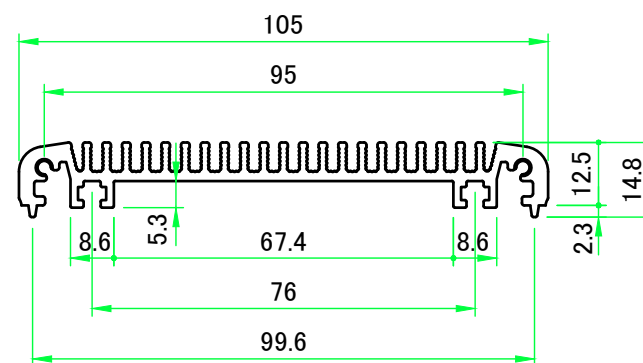
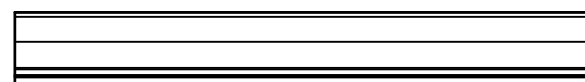
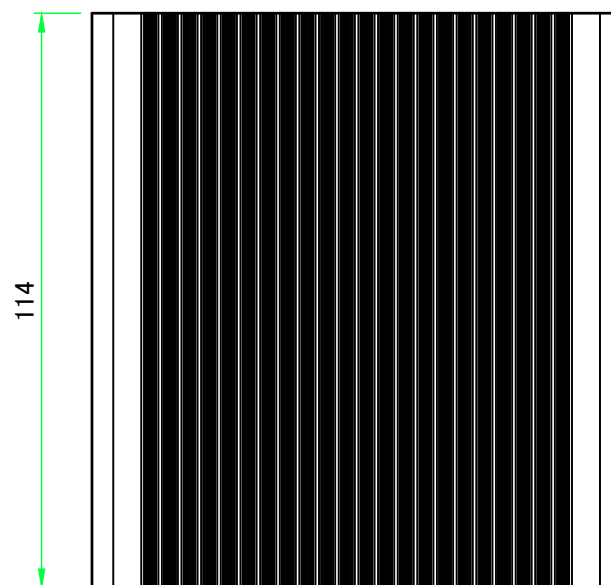

株式会社タカチ電機工業 TAKACHI ELECTRONICS ENCLOSURE CO., LTD.			品名/Title ヒートシンクアルミケース HEAT-SINK ALUMINIUM ENCLOSURE	尺度/Scale 1:2
承認/Approved	検図/Checked	製図/Created	型番/Product number EXH11-3-12□□	
	大江	岡本	作成日/Date 2017/04/03	2 / 5

ヒートシンク / Heat-sink

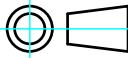

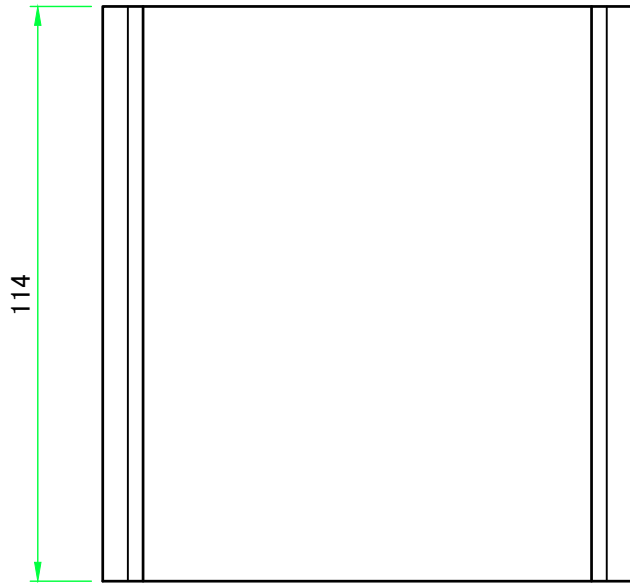
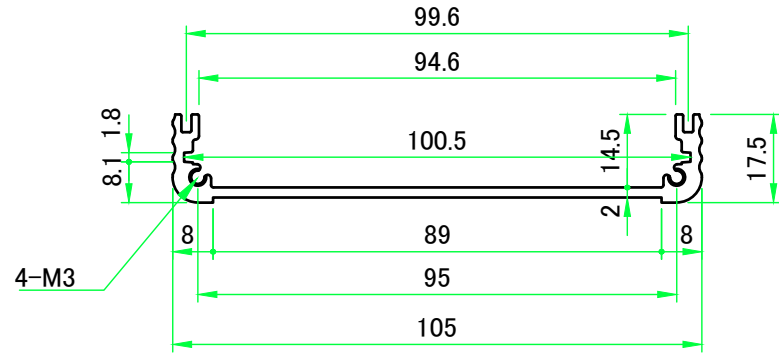
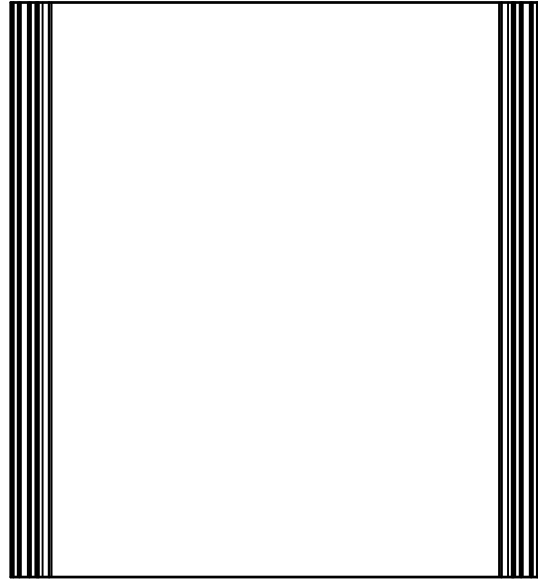
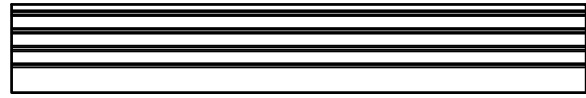
 株式会社タカチ電機工業 TAKACHI ELECTRONICS ENCLOSURE CO., LTD.		品名/Title ヒートシンクアルミケース HEAT-SINK ALUMINIUM ENCLOSURE		 尺度/Scale 1 : 1.5
承認/Approved	検図/Checked	製図/Created	型番/Product number EXH11-□-12□□	
	大江	岡本	作成日/Date 2017/04/04	3 / 5



 株式会社タカチ電機工業 TAKACHI ELECTRONICS ENCLOSURE CO., LTD.		品名/Title 下カバー BOTTOM COVER		
承認/Approved	検図/Checked	製図/Created	型番/Product number W105-H30-D114	
	大江	岡本	作成日/Date 2017/03/23	4 / 5

パネル / Panel

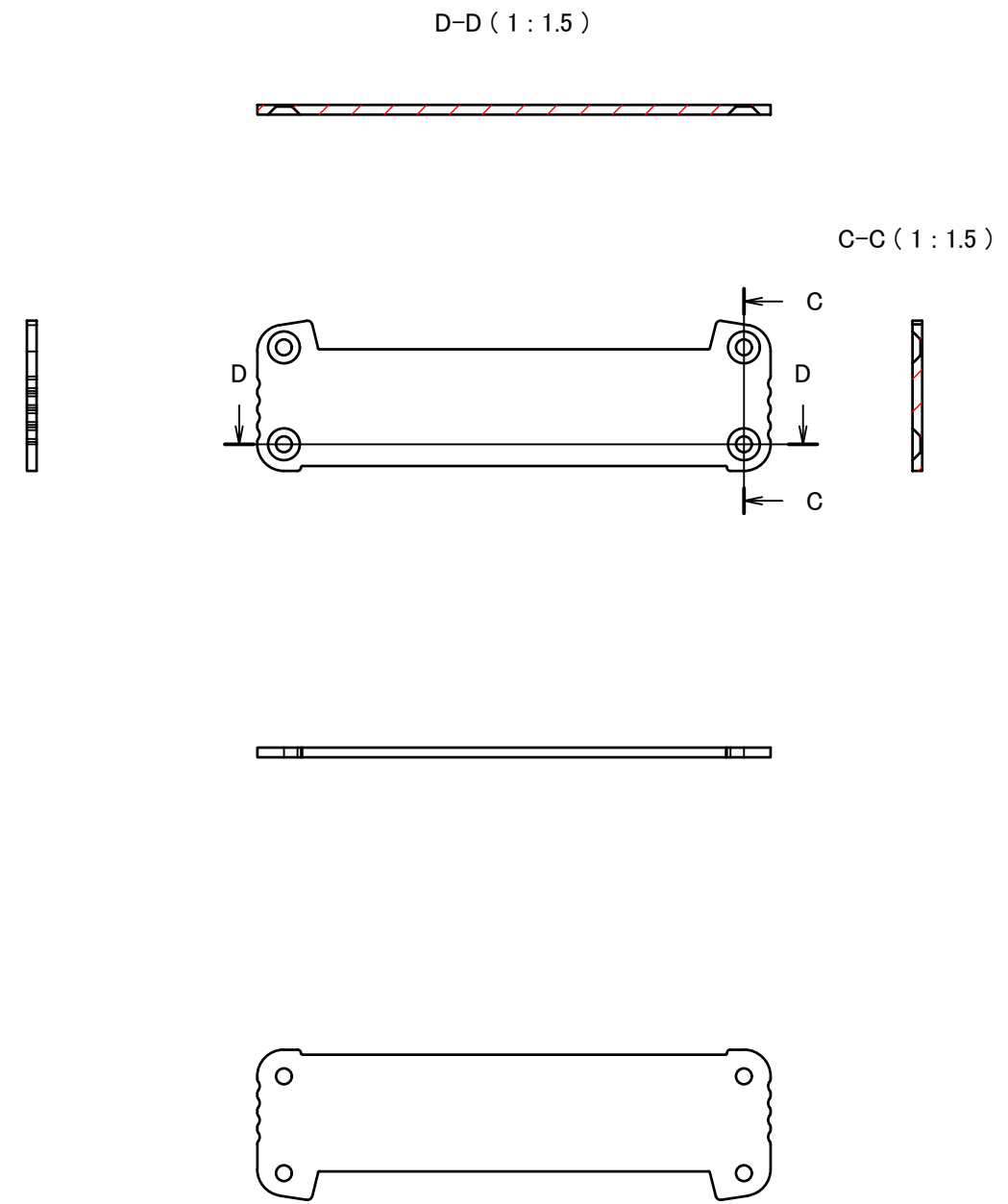
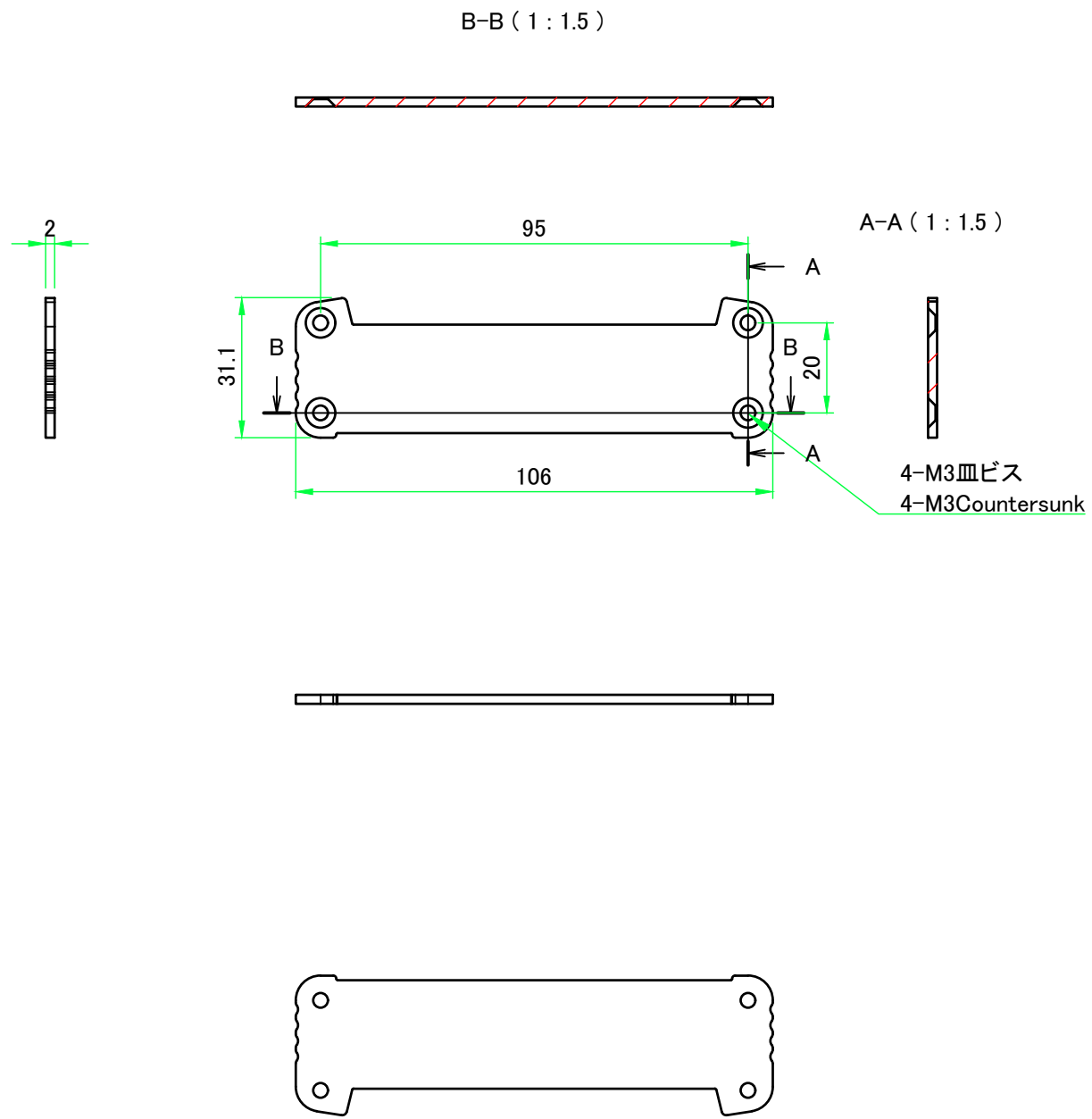

株式会社タカチ電機工業 TAKACHI ELECTRONICS ENCLOSURE CO., LTD.		品名/Title ヒートシンクアルミケース HEAT-SINK ALUMINIUM ENCLOSURE	尺度/Scale 1:1.5
承認/Approved	検図/Checked	製図/Created	
	大江	岡本	作成日/Date 2017/04/05
			5 / 5