

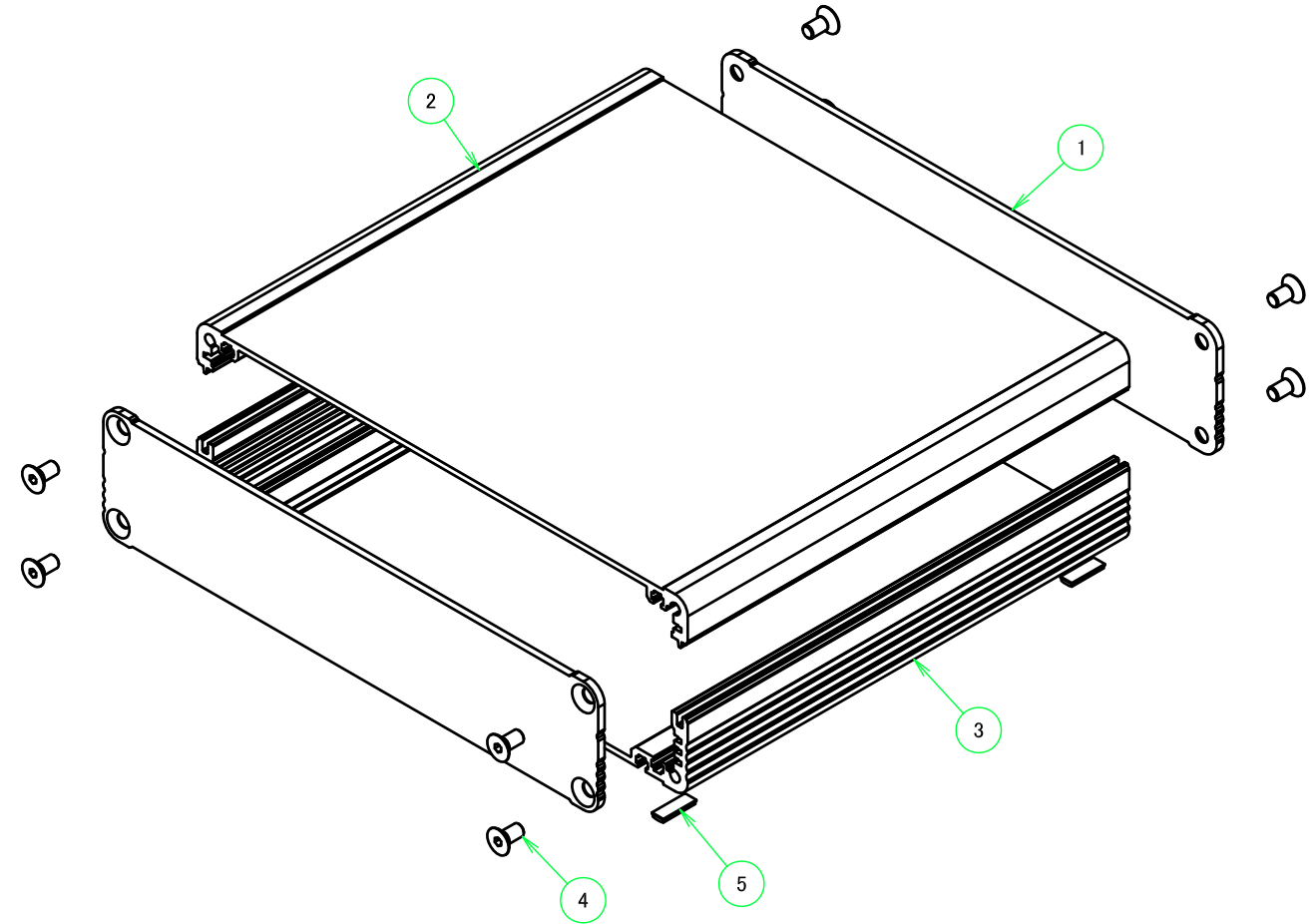

構成内容 / Components				
No.	名称 / Part name	数量 / Pcs	材質 / Material	色・表面処理 / Color・Finish
1	パネル / End panel	2	アルミ板 / Aluminium A1050P	ブラック, シルバー・アルマイト / Black, Silver・anodized
2	上カバー / Top cover	1	アルミ押出材 / Extruded aluminium A6063S-T5	ブラック, シルバー・アルマイト & クリア塗装 / Black, Silver・anodized & clear coated
3	下カバー / Bottom cover	1	アルミ押出材 / Extruded aluminium A6063S-T5	ブラック, シルバー・アルマイト & クリア塗装 / Black, Silver・anodized & clear coated
4	取付ビス(六角穴付皿 M5×10) / Screw	8	ステンレス / Stainless steel	無処理 / Unfinished
5	ゴム足 / Rubber feet	4	ポリウレタン / Polyurethane	ブラック / Black

※ゴム足は任意の場所に貼り付けできます。
 ※Adhesive rubber feet included.

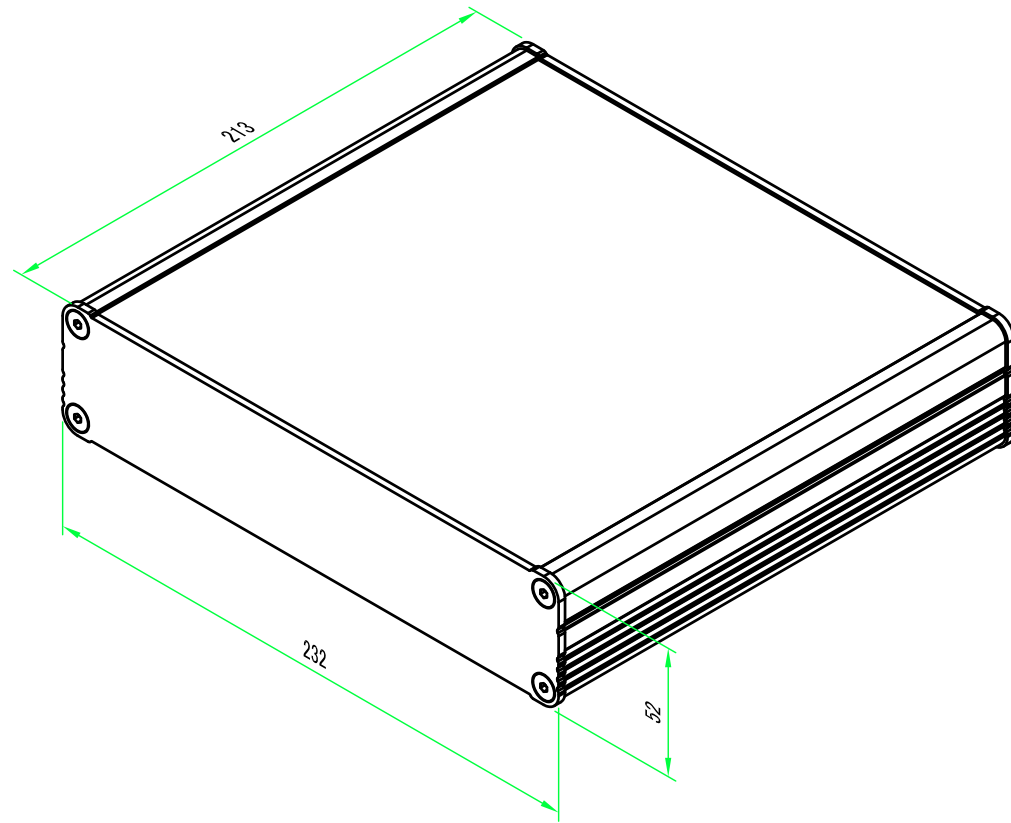

色仕様(型番末尾□) / Color type		
記号 / Code	上下カバー / Cover	パネル / Panel
S S	シルバー / Silver	シルバー / Silver
S B	シルバー / Silver	ブラック / Black
B S	ブラック / Black	シルバー / Silver
B B	ブラック / Black	ブラック / Black

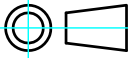
 株式会社タカチ電機工業 <small>TAKACHI ELECTRONICS ENCLOSURE CO., LTD.</small>			品名/Title アルミ押出材ケース EXTRUDED ALUMINIUM CASE	 尺度/Scale 1 : 2.5
承認/Approved	検図/Checked	製図/Created	型番/Product number EX23-5-21□□	
中根	大江	岡本	作成日/Date 2020/11/24	1 / 5

ゴム足
Rubber feet

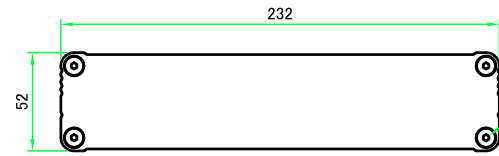
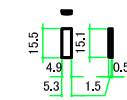

4-M5皿ビス
4-M5 Countersunk

B-B (1:4)

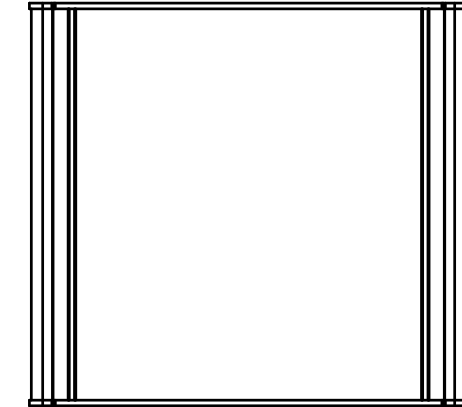
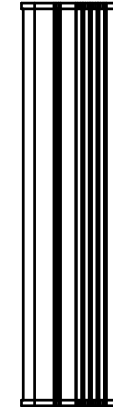
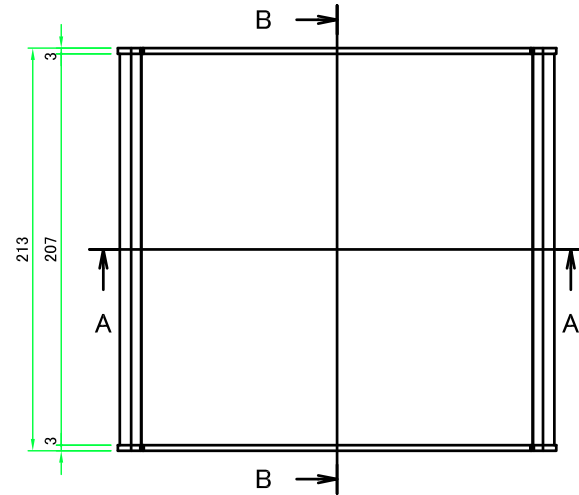
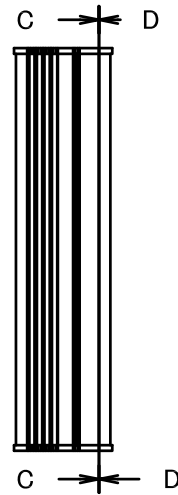
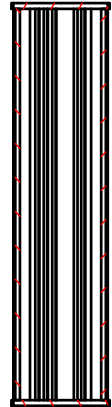

C-C (1:4)

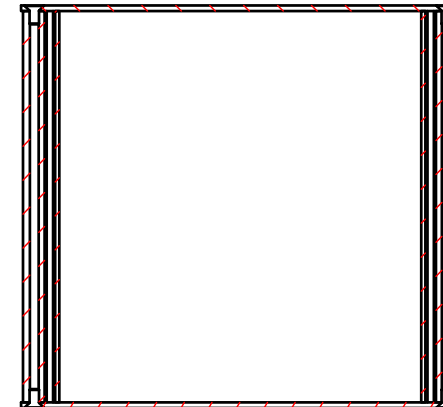

D-D (1:4)

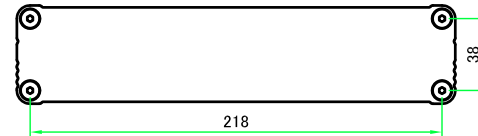
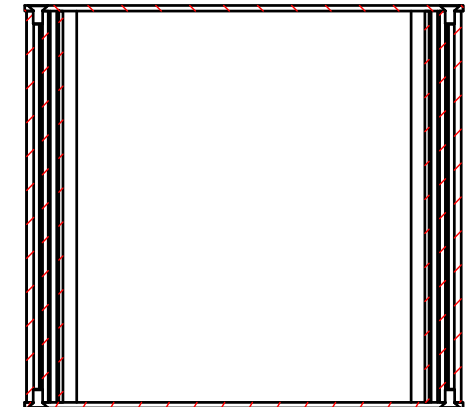

A-A (1:4)

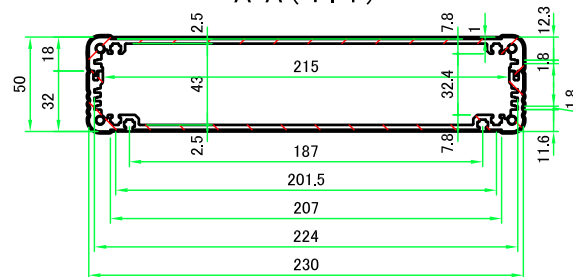

株式会社タカチ電機工業 TAKACHI ELECTRONICS ENCLOSURE CO., LTD.			品名/Title アルミ押出材ケース EXTRUDED ALUMINIUM CASE	尺度/Scale 1:4
承認/Approved	検図/Checked	製図/Created	型番/Product number EX23-5-21□□	
中根	大江	岡本	作成日/Date 2019/01/24	2 / 5

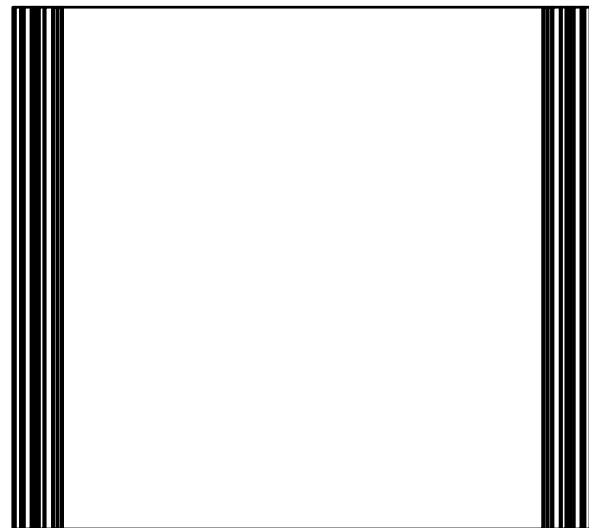
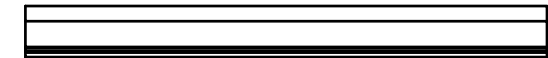
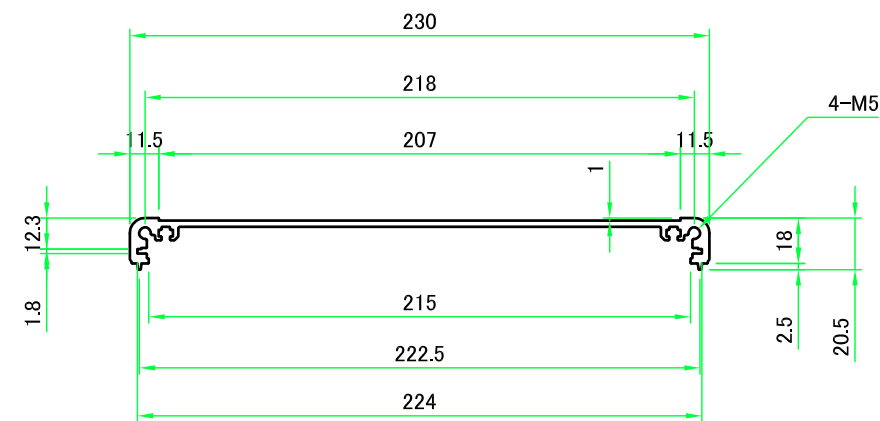
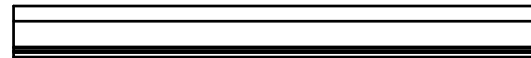
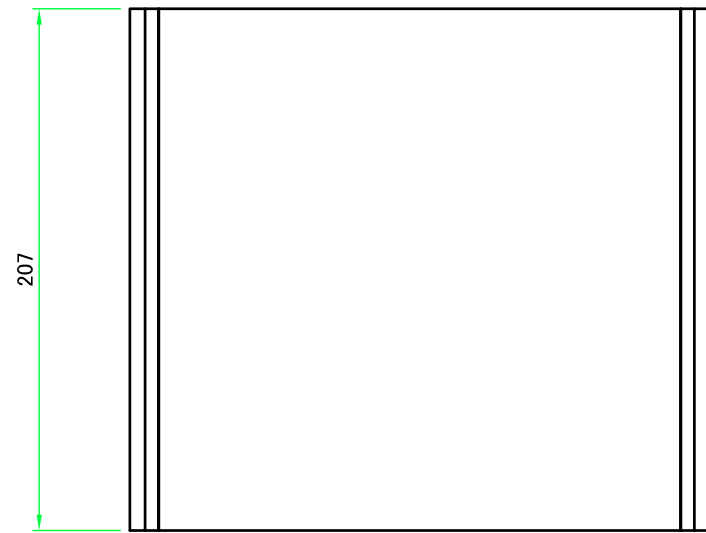

株式会社タカチ電機工業 TAKACHI ELECTRONICS ENCLOSURE CO., LTD.			品名/Title 上カバー TOP COVER	尺度/Scale 1:3
承認/Approved	検図/Checked	製図/Created	型番/Product number W230-D207	
中根	岡本	大江	作成日/Date 2019/01/15	3 / 5

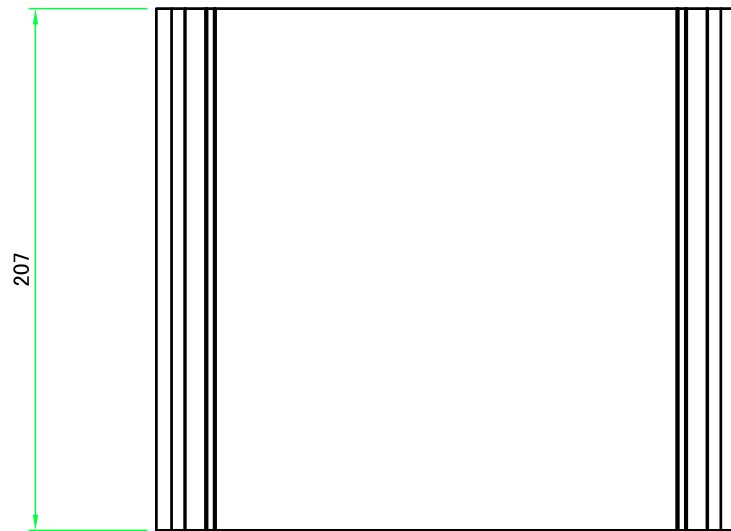
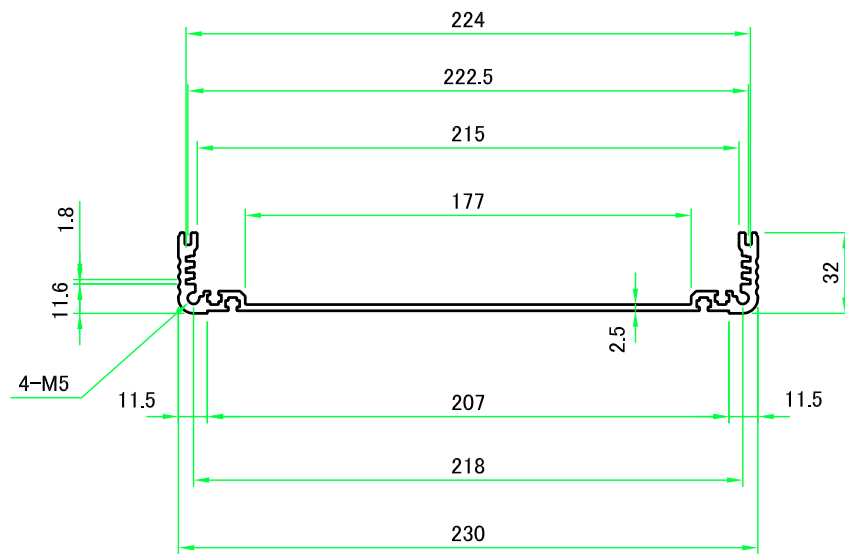
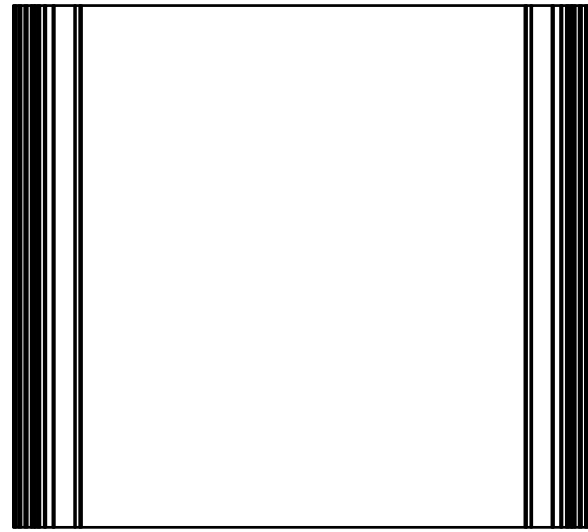

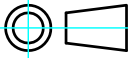
 株式会社タカチ電機工業 TAKACHI ELECTRONICS ENCLOSURE CO., LTD.			品名/Title 下カバー BOTTOM COVER	 尺度/Scale 1:3
承認/Approved	検図/Checked	製図/Created	型番/Product number W230-H50-D207	
中根	岡本	大江	作成日/Date 2019/01/15	4 / 5

パネル / End panel

B-B (1:2.5)

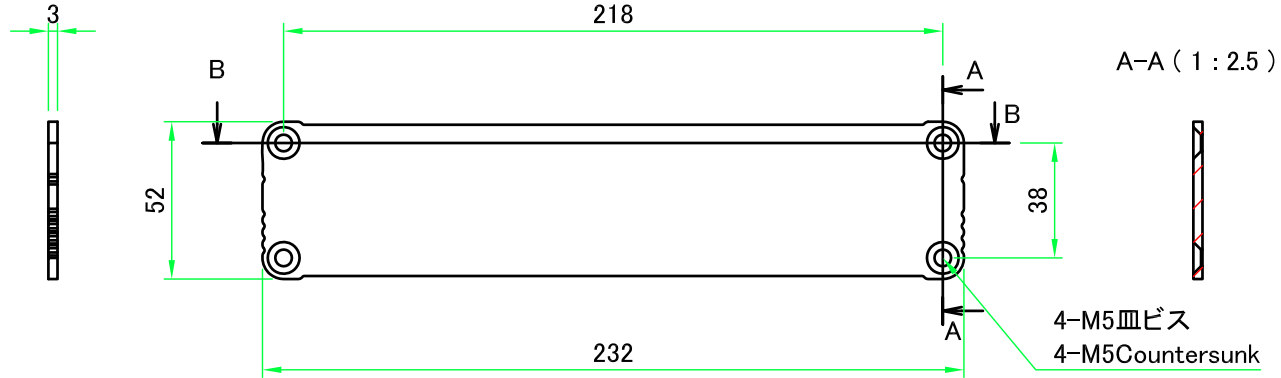

A-A (1:2.5)



4-M5皿ビス
4-M5Countersunk

表面 / Outside



裏面 / Inside

D-D (1:2.5)

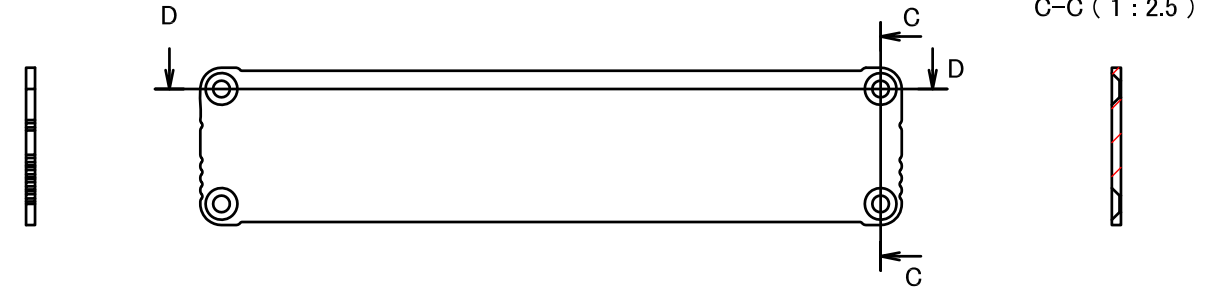

C-C (1:2.5)



表面 / Outside



裏面 / Inside

株式会社タカチ電機工業 TAKACHI ELECTRONICS ENCLOSURE CO., LTD.			品名/Title パネル END PANEL	尺度/Scale 1:2.5
承認/Approved	検図/Checked	製図/Created	型番/Product number W230 - H50	
中根	大江	岡本	作成日/Date 2020/11/24	5 / 5